



Electronic Products

DEGSON Terminal Block

NINGBO DEGSON ELECTRICAL CO., LTD.
ISO9001 ISO14001 ISO80079-34 ISO/TS22163 IATF16949

DEGSON Circular Connectors

NINGBO DEGSON ELECTRICAL CO., LTD.
ISO9001 ISO14001 ISO80079-34 ISO/TS22163 IATF16949

DEGSON Heavy Duty Connector

NINGBO DEGSON ELECTRICAL CO., LTD.
ISO9001 ISO14001 ISO80079-34 ISO/TS22163 IATF16949

DEGSON DIN Rail Terminal Blocks And Accessories System

NINGBO DEGSON ELECTRICAL CO., LTD.
ISO9001 ISO14001 ISO80079-34 ISO/TS22163 IATF16949

DEGSON EV Charging Cable

DEGSON TECHNOLOGY CO.,LTD.
IATF16949

DEGSON Customized Product

NINGBO DEGSON ELECTRICAL CO., LTD.
ISO9001 ISO14001 ISO80079-34 ISO/TS22163 IATF16949

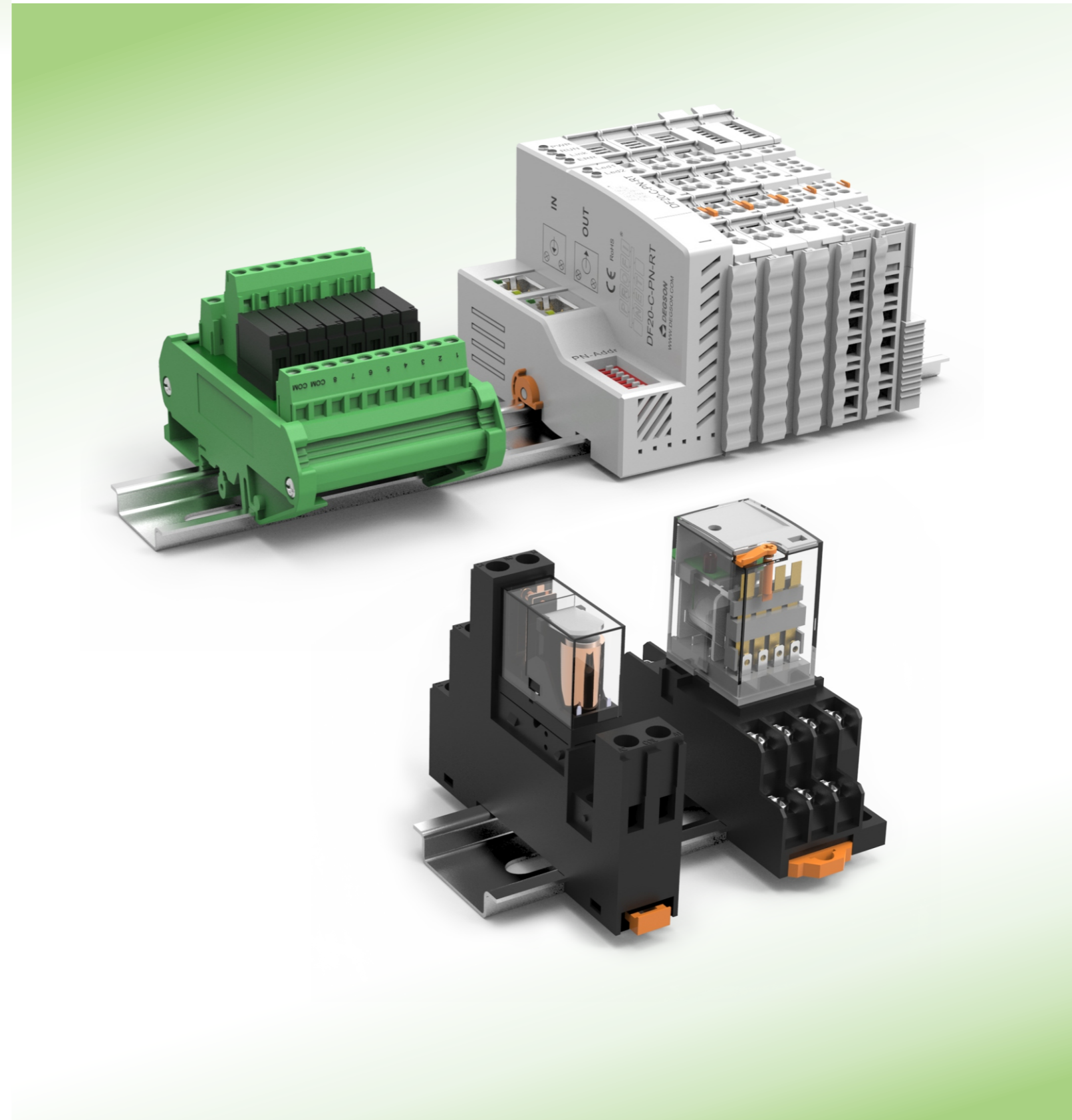

DEGSON
NINGBO DEGSON ELECTRICAL CO., LTD.

Add: No.1585.Xiaolin Road.Cixi.Ningbo China
P.C.: 315321
www.degson.com

Tel: +86-574-63510770
E-mail: sale@degson.com



DEGSON website

EP 22-E02

Brief Introduction

Founded in 1990, DEGSON is a global solution provider of electrical, electronic and industrial connectors. As a National High-tech enterprise, DEGSON owns the UL and VDE certified laboratory. The company achieved ISO9001, ISO14001, ISO80079-34, ISO/TS22163 and IATF16949 management system certifications.

DEGSON is engaged in supplying highly reliable and durable products to serve global customers. The company has a market-leading capability of mould processing, automatic manufacturing and advanced testing. DEGSON has the complete engineering ability to support global customers with the professional customization solution and value-added service.

DEGSON products are widely recognized in China, the USA, Germany, the UK, Italy, Spain, Turkey, Japan, South Korea, Singapore, etc. totally hundred countries and regions. DEGSON supply high quality products and provide professional services globally in the industry sectors likely industrial automation, instrument, electric power, railway, marine and offshore, new energy, E-bike industrial elevator, lighting, security, machinery, etc. The company won the recognition from partners among Fortune 500 and industry leading enterprises.

Based on the business philosophy of “pragmatic innovation, responsibility, integrity, harmonious development, regulation and win-win”, DEGSON continuously integrates professional technical resources, R&D innovation, product manufacturing and technology application capabilities. Relying on global sales network, DEGSON aims to supply series of multiple varieties of high-quality products and services. We provide global customers with professional and quick connected application solutions, help customers continue to create value. DEGSON is making contributions to creating a smart and interconnected world.



First Lab. authorized by UL&VDE in Asia

Strategic cooperation with UL and VDE



① The general manager of UL global energy & technology division visit our company



② Sven Ohrke, President of VDE global services, comes to DEGSON to discuss strategic cooperation



③ VDE Laboratory Accreditation: In July 2010, VDE Issued the "VDE Authorized Laboratory" Certificate to DEGSON's laboratory.
UL laboratory accreditation: UL formally issued "UL WTDP" certification to DEGSON in March 2013. On April, 2016, UL-CTDP. On December, 2016, VDE-TDAP. On January, 2017, Pass IRIS system audit.



ISO9001

ISO14001

ISO/TS22163

UL - CTDP

VDE - TDAP

EX certificate



UL Certificates:10, Covering 4000+Products

VDE Certificates:175, Covering 3000+Products

TUV certificate

EAC certificate

CE certificate

European invention patent

CONTENTS

IP20 I/O SYSTEM

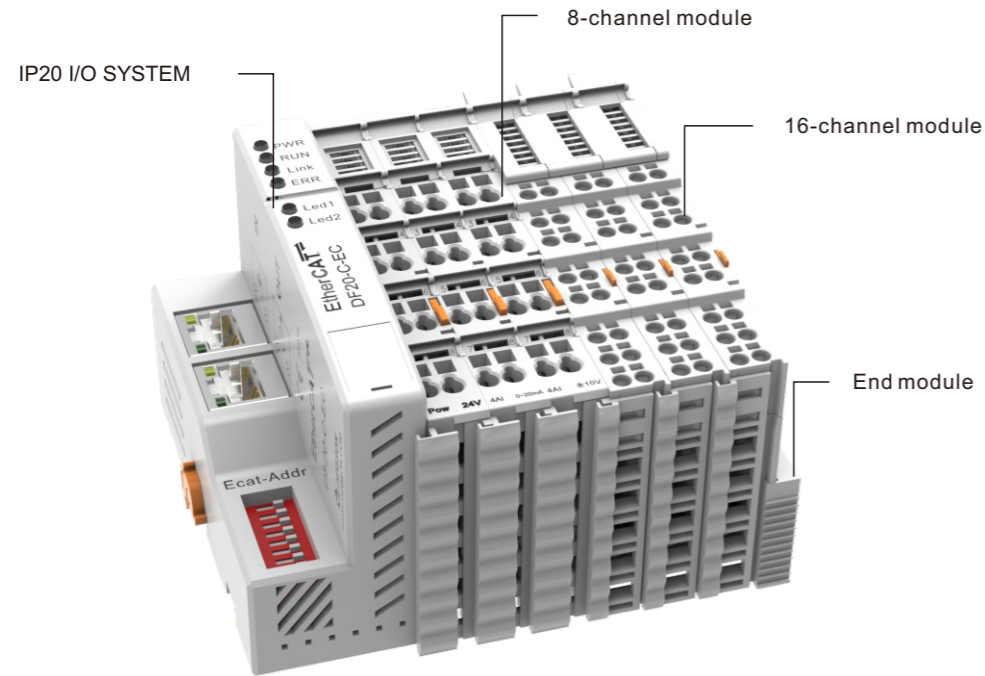

NB: New DF50 product family available.
See:
<https://styreteknik.dk/24-remote-io>

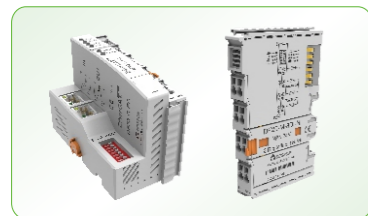

IP20 I/O system 01-30



Unmanaged switch31-36



Universal single phase switching power supply37-40

CONTENTS

All Relays

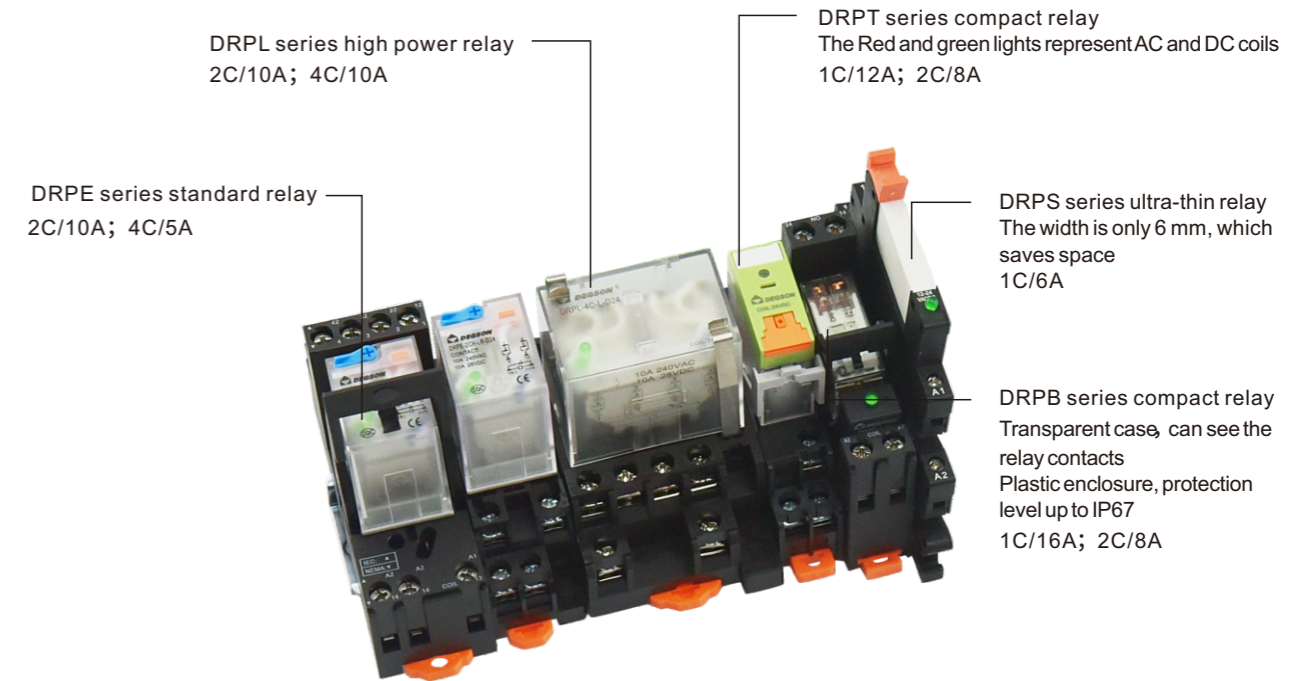

Power relay series 41-68



JB series junction box 69-86

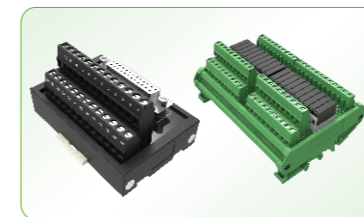

Interface module series87-100

Relay module series101-110



DF20-C-PN-RT-V1

PROFINET, 2 RJ45, expandable 32 modules, 24VDC

Features

- With a power module.
- LED display working status, alarm and bus fault prompt.
- Two PROFINET interface (RJ45, 10/100Mbps).
- With Media Redundancy Protocol.

New DF50 product family available. See:
<https://styreteknik.dk/24-remote-io>

Specification	
Product	DF20-C-PN-RT-V1
Communication protocol	PROFINET
Transmission rate	10/100Mbps, full duplex
Transmission distance	100 meters
PDO data	1024 bytes
Number of extensible modules	32
Address mapping	Yes
Address setting	PROFINET specification
Transmission medium	Class 5 twisted pair cable
Isolation method	Electrical isolation
Features	RT, conforming to Class C, MRP, automatic addressing/topology detection
Alarm function	Diagnostic alarm, process alarm, plug and unplug connector alarm
Minimum cycle time	1ms
Power Supply Parameters	
Connection type	Spring terminal blocks
Working voltage	24V DC +20 %/ -15 %
Current without load	<350mA
Maximum area of wire	2.5mm ²
Maximum area of wire (AWG)	AWG14
The minimum area of a wire	0.2mm ²
The minimum area of a wire (AWG)	AWG28
Strip length	8...9mm
Supply system voltage	5VDC
Supply system current	Max.0.4A
Supply load voltage	24V...32VDC
Supply load current (MAX)	5A

Product	DF20-C-PN-RT-V1
Mechanical Structure	
Protection grade	IP20
Size(H X W X D)	100mm X 48mm X 69mm
Installation type	35mm DIN
Work Environment	
Working temperature	-25...60°C
Storage temperature	-40...85°C
Relative humidity	5... 95%RH(non-condensing)
LED Status Indicator	
PWR	Green: Power is working
RUN	Green: I/O system is running
LINK	Blinking green: The module is working
ERR	Red: An error occurred between I/O system and module
LED1	Green : PORT 1 connected successfully.
	Green blinking : Port 1 has data communication.
LED2	Green : PORT 2 connected successfully.
	Green blinking : Port 2 has data communication.
POWER-1, POWER-2	Green:The system power is working
POWER-7, POWER-8	Green: The load power is working

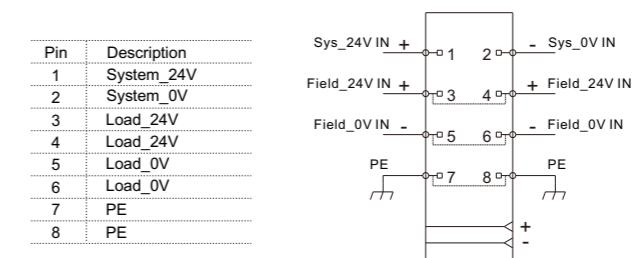
Wiring Diagram

DF20-C-PN-RT-V1



DF20-C-EC

EtherCAT, 2 RJ45, expandable 31 modules, 24VDC

Features

- With a power module.
- LED display working status, alarm and bus fault prompt.
- Two EtherCAT interface (RJ45, 100Mbps).

Specification

Product	DF20-C-EC
Communication protocol	EtherCAT
Connection type	2 X RJ45, with switch function
Transmission rate	10/100Mbps, full duplex
Transmission distance	100 meters
PDO data	1024 bytes
Number of extensible modules	31
Address mapping	Yes
Address setting	EtherCAT specification, DIP switch
Alias range	1~254
Transmission medium	Class 5 twisted pair cable
Isolation method	Electrical isolation

Power Supply Parameters

Connection type	Spring terminal blocks
Working voltage	24V DC +20% / -15%
Current without load	<150mA
Maximum area of wire	2.5mm ²
Maximum area of wire (AWG)	AWG14
The minimum area of a wire	0.2mm ²
The minimum area of a wire (AWG)	AWG28
Strip length	8...9mm
Supply system voltage	5VDC
Supply system current	Max.0.6A
Supply load voltage	24V~32VDC
Supply load current (MAX)	5A

Product	DF20-C-EC
Mechanical Structure	
Protection grade	IP20
Size(H X W X D)	100mm X 48mm X 69mm
Installation type	35mm DIN
Work Environment	
Working temperature	-25...60°C
Storage temperature	-40...85°C
Relative humidity	5... 95%RH(non-condensing)
LED Status Indicator	
PWR	Green: Power is working
RUN	Green Off: The I/O system is being initialized.
	Green slow blinking: The I/O system is prerunning.
	Green fast blinking: The I/O system is operating safely.
	Green: The I/O system is running.
LINK	Blinking green: The module is working.
ERR	Red: An error occurred between I/O system and module.
LED1	/
LED2	/
POWER-1, POWER-2	Green: The system power is working.
POWER-7, POWER-8	Green: The load power is working.

Wiring Diagram

Pin	Description
1	System_24V
2	System_0V
3	Load_24V
4	Load_24V
5	Load_0V
6	Load_0V
7	PE
8	PE

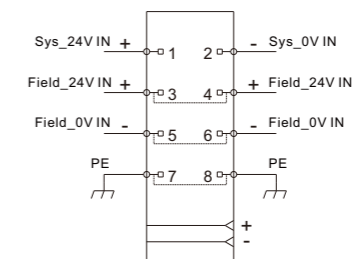

DF20-C-EC



DF20-C-EN-IP

EtherNET IP, 2 RJ45, expandable 32 modules, 24VDC

Features

- With a power module.
- LED display working status, alarm and bus fault prompt.
- Two EtherNET IP interface (RJ45, 10/100Mbps).

Specification

Product	DF20-C-EN-IP
Communication protocol	EtherNET IP
Transmission rate	10/100Mbps, full duplex
Transmission distance	100 meters
PDO data	1024 bytes
Number of extensible modules	32
Address mapping	Yes
Address setting	EtherNET IP specification, DIP switch
Transmission medium	Class 5 twisted pair cable
Isolation method	Electrical isolation
Alarm function	Diagnostic alarm, process alarm, plug and unplug connector alarm
Minimum cycle time	1ms

Power Supply Parameters

Connection type	Spring terminal blocks
Working voltage	24V DC +20 %/ -15 %
Current without load	<350mA
Maximum area of wire	2.5mm ²
Maximum area of wire (AWG)	AWG14
The minimum area of a wire	0.2mm ²
The minimum area of a wire (AWG)	AWG28
Strip length	8...9mm
Supply system voltage	5VDC
Supply system current	Max.0.4A
Supply load voltage	24V...32VDC
Supply load current (MAX)	5A

Product	DF20-C-EN-IP
Mechanical Structure	
Protection grade	IP20
Size(H X W X D)	100mm X 48mm X 69mm
Installation type	35mm DIN
Work Environment	
Working temperature	-25...60°C
Storage temperature	-40...85°C
Relative humidity	5... 95%RH(non-condensing)
LED Status Indicator	
PWR	Green: Power is working
RUN	Green: I/O system is running
LINK	Blinking green: The module is working
ERR	Red: An error occurred between I/O system and module
LED1	Green : PORT 1 connected successfully.
	Green blinking : Port 1 has data communication.
LED2	Green : PORT 2 connected successfully.
	Green blinking : Port 2 has data communication.
POWER-1, POWER-2	Green:The system power is working
POWER-7, POWER-8	Green: The load power is working

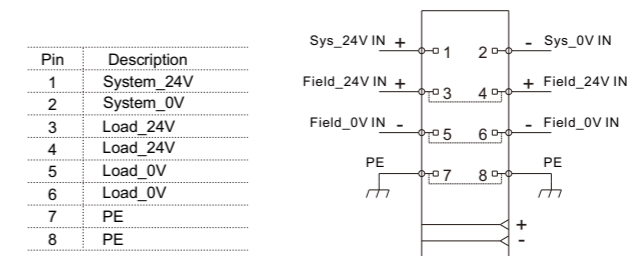
Wiring Diagram

DF20-C-EN-IP



DF20-C-CC-FB

CC-LINK IE Field Basic, 1 RJ45, expandable 16 modules, 24VDC

Features

- With a power module.
- LED display working status, alarm and bus fault prompt.
- CC-LINK IE Field Basic interface (RJ45, 10/100Mbps).

Specification

Product	DF20-C-CC-FB
Communication protocol	CC-LINK IE Field Basic
Transmission rate	10/100Mbps
Transmission distance	100 meters
PDO data	576 bytes
Number of extensible modules	16
Address mapping	yes
Address setting	CC-LINK IE Field Basic specification, DIP switch
Address range	2-253
Transmission medium	Class 5 twisted pair cable
Isolation method	Electrical isolation

Power Supply Parameters

Connection type	Spring terminal blocks
Working voltage	24V DC +20 % / -15 %
Current without load	<150mA
Maximum area of wire	2.5mm ²
Maximum area of wire (AWG)	AWG14
The minimum area of a wire	0.2mm ²
The minimum area of a wire (AWG)	AWG28
Strip length	8...9mm
Supply system voltage	5VDC
Supply system current	Max.0.6A
Supply load voltage	24V...32VDC
Supply load current (MAX)	5A

Product	DF20-C-CC-FB
Mechanical Structure	
Protection grade	IP20
Size(H X W X D)	100mm X 48mm X 69mm
Installation type	35mm DIN
Work Environment	
Working temperature	-25...60°C
Storage temperature	-40...85°C
Relative humidity	5... 95%RH(non-condensing)
LED Status Indicator	
PWR	Green: Power is working
RUN	Green: I/O system is running
LINK	Blinking green: The module is working
ERR	Red: An error occurred between I/O system and module
LED1	/
LED2	/
POWER-1, POWER-2	Green:The system power is working
POWER-7, POWER-8	Green: The load power is working

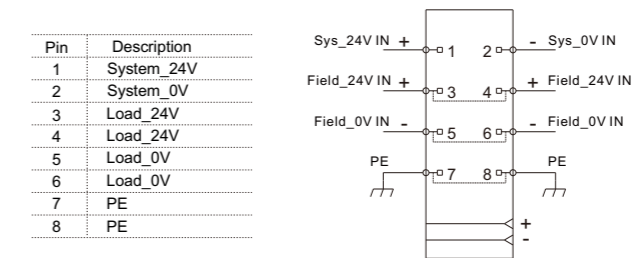
Wiring Diagram

DF20-C-CC-FB



DF20-C-MD-TCP

Modbus TCP/IP, 1 RJ45, expandable 16 modules, 24VDC

Features

- With a power module.
- LED display working status, alarm and bus fault prompt.
- Modbus TCP/IP interface (RJ45,10/100Mbps)

Specification	
Product	DF20-C-MD-TCP
Communication protocol	Modbus TCP/IP
Transmission rate	10/100Mbps
Transmission distance	100 meters
PDO data	1024 bytes
Number of extensible modules	16
Support Modbus function	02,03,05,06,15,16
Address mapping	yes
Address setting	Modbus TCP/IP specification, DIP switch
Address range	2~253
Transmission medium	Class 5 twisted pair cable
Isolation method	Electrical isolation
Power Supply Parameters	
Connection type	Spring terminal blocks
Working voltage	24V DC +20 % / -15 %
Current without load	<150mA
Maximum area of wire	2.5mm ²
Maximum area of wire (AWG)	AWG14
The minimum area of a wire	0.2mm ²
The minimum area of a wire (AWG)	AWG28
Strip length	8...9mm
Supply system voltage	5VDC
Supply system current	Max.0.6A
Supply load voltage	24V...32VDC
Supply load current (MAX)	5A

Product	DF20-C-MD-TCP
Mechanical Structure	
Protection grade	IP20
Size(H X W X D)	100mm X 48mm X 69mm
Installation type	35mm DIN
Work Environment	
Working temperature	-25...60°C
Storage temperature	-40...85°C
Relative humidity	5... 95%RH(non-condensing)
LED Status Indicator	
PWR	Green: Power is working
RUN	Green: I/O system is running
LINK	Blinking green: The module is working
ERR	Red: An error occurred between I/O system and module
LED1	/
LED2	/
POWER-1, POWER-2	Green:The system power is working
POWER-7, POWER-8	Green: The load power is working
Wiring Diagram	

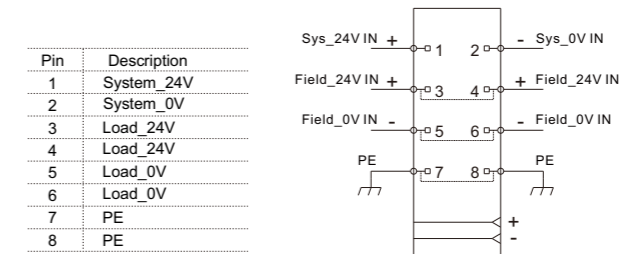

DF20-C-MD-TCP

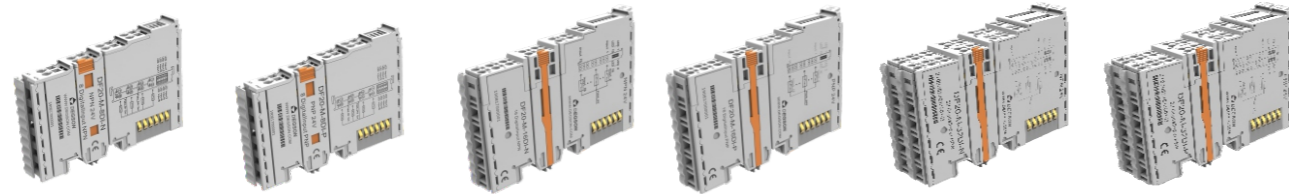

DF20-M-8DI-N DF20-M-8DI-P DF20-M-16DI-N DF20-M-16DI-P DF20-M-32DI-N DF20-M-32DI-P

Digital input module, 8 ports, NPN, 24VDC	Digital input module, 8 ports, PNP, 24VDC	Digital input module, 16 ports, NPN, 24VDC	Digital input module, 16 ports, PNP, 24VDC	Digital input module, 32 ports, NPN, 24VDC	Digital input module, 32 ports, PNP, 24VDC
---	---	--	--	--	--

Specification

Product	DF20-M-8DI-N	DF20-M-8DI-P	DF20-M-16DI-N	DF20-M-16DI-P	DF20-M-32DI-N	DF20-M-32DI-P
Number of channels	8		16		32	
Data size	1 Byte		2 Byte		4 Byte	
Signal type	NPN	PNP	NPN	PNP	NPN	PNP
"0" signal voltage	18V...32V	0V...4V	18V...32V	0V...4V	18V...32V	0V...4V
"1" signal voltage	0V...4V	18V...32V	0V...4V	18V...32V	0V...4V	18V...32V
Connection type	1-line					
Reverse protection	Yes					
Isolation method	Photoelectric isolation					
Fault diagnosis	Yes					
Typical input current	3mA					
Filtering time	0.3ms					
Precision	0.20%					

Power Supply Parameters

Connection type	Spring terminal blocks					
Working voltage	24V DC +20% / -15%					
System feed current	<14mA		<15mA		<30mA	
Maximum area of wire	2.5mm ²		1.5mm ²			
Maximum area of wire (AWG)	AWG14		AWG16			
The minimum area of a wire	0.2mm ²		0.2mm ²			
The minimum area of a wire (AWG)	AWG28		AWG28			
Strip length	8...9mm		8...9mm			

Product	DF20-M-8DI-N	DF20-M-8DI-P	DF20-M-16DI-N	DF20-M-16DI-P	DF20-M-32DI-N	DF20-M-32DI-P
Mechanical Structure						
Protection grade	IP20					
Size(H X W X D)	100mm X 12mm X 69mm			100mm X 24mm X 69mm		
Installation type	35mm DIN					
Work Environment						
Working temperature	-25...60°C					
Storage temperature	-40...85°C					
Relative humidity	5...95%RH(non-condensing)					
LED Status Indicator						
Channel Light	Green: The input signal of each channel is working.					
Wiring Diagram						

Pin	Description
1	Input 0
2	Input 1
3	Input 2
4	Input 3
5	Input 4
6	Input 5
7	Input 6
8	Input 7

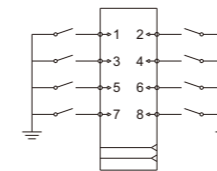

DF20-M-8DI-N

Pin	Description	Pin	Description
1	Input 0	9	Input 8
2	Input 1	10	Input 9
3	Input 2	11	Input 10
4	Input 3	12	Input 11
5	Input 4	13	Input 12
6	Input 5	14	Input 13
7	Input 6	15	Input 14
8	Input 7	16	Input 15

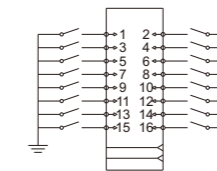

DF20-M-16DI-N

Pin	Description
1	Input 0
2	Input 1
3	Input 2
4	Input 3
5	Input 4
6	Input 5
7	Input 6
8	Input 7

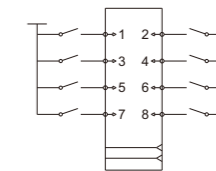

DF20-M-8DI-P

Pin	Description	Pin	Description
1	Input 0	9	Input 8
2	Input 1	10	Input 9
3	Input 2	11	Input 10
4	Input 3	12	Input 11
5	Input 4	13	Input 12
6	Input 5	14	Input 13
7	Input 6	15	Input 14
8	Input 7	16	Input 15

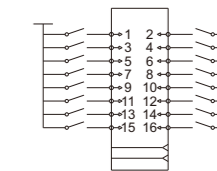

DF20-M-16DI-P

Pin	Description	Pin	Description	Pin	Description	Pin	Description
1	Input 0	9	Input 8	17	Input 16	25	Input 24
2	Input 1	10	Input 9	18	Input 17	26	Input 25
3	Input 2	11	Input 10	19	Input 18	27	Input 26
4	Input 3	12	Input 11	20	Input 19	28	Input 27
5	Input 4	13	Input 12	21	Input 20	29	Input 28
6	Input 5	14	Input 13	22	Input 21	30	Input 29
7	Input 6	15	Input 14	23	Input 22	31	Input 30
8	Input 7	16	Input 15	24	Input 23	32	Input 31

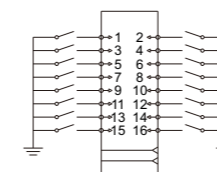

DF20-M-32DI-N

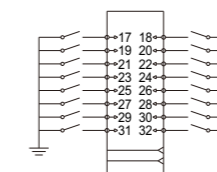

DF20-M-32DI-P

Pin	Description	Pin	Description	Pin	Description	Pin	Description
1	Input 0	9	Input 8	17	Input 16	25	Input 24
2	Input 1	10	Input 9	18	Input 17	26	Input 25
3	Input 2	11	Input 10	19	Input 18	27	Input 26
4	Input 3	12	Input 11	20	Input 19	28	Input 27
5	Input 4	13	Input 12	21	Input 20	29	Input 28
6	Input 5	14	Input 13	22	Input 21	30	Input 29
7	Input 6	15	Input 14	23	Input 22	31	Input 30
8	Input 7	16	Input 15	24	Input 23	32	Input 31

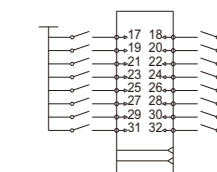
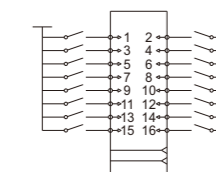

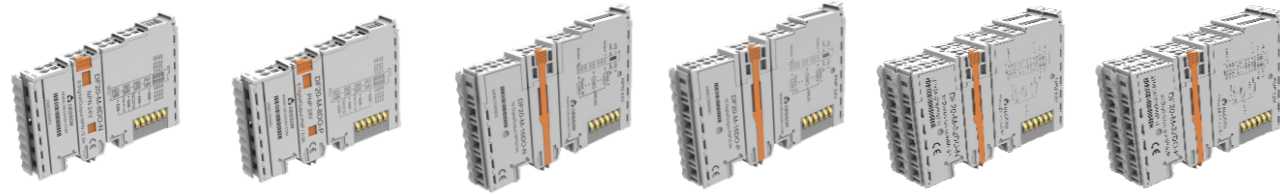

DF20-M-8DO-N DF20-M-8DO-P DF20-M-16DO-N DF20-M-16DO-P DF20-M-32DO-N DF20-M-32DO-P

Digital output module, 8 ports, NPN, 24VDC	Digital output module, 8 ports, PNP, 24VDC	Digital output module, 16 ports, NPN, 24VDC	Digital output module, 16 ports, PNP, 24VDC	Digital output module, 32 ports, NPN, 24VDC	Digital output module, 32 ports, PNP, 24VDC
--	--	---	---	---	---

Specification

Product	DF20-M-8DO-N	DF20-M-8DO-P	DF20-M-16DO-N	DF20-M-16DO-P	DF20-M-32DO-N	DF20-M-32DO-P
Number of channels	8		16		32	
Data size	1 Byte		2 Byte		4 Byte	
Signal type	NPN	PNP	NPN	PNP	NPN	PNP
"0" signal voltage	high-impedance state	high-impedance state	high-impedance state	high-impedance state	high-impedance state	high-impedance state
"1" signal voltage	0V DC	24V DC	0V DC	24V DC	0V DC	24V DC
Connection type	1-line					
Reverse protection	Yes					
Isolation method	Photoelectric isolation					
Switching Frequency (resistance/lamp load)	<1000Hz					
Switching Frequency (Inductive load)	<0.2Hz					
Response Time of the Protection Circuit	< 100µs					
Output current per channel(MAX)	500 mA					
Load type	Inductance, resistance, lamp					

Power Supply Parameters

Connection type	Spring terminal blocks					
Working voltage	24V DC +20 % / - 15 %					
System feed current	<50mA		<75mA		<100mA	
Maximum area of wire	2.5mm ²		1.5mm ²			
Maximum area of wire (AWG)	AWG14		AWG16			
The minimum area of a wire	0.2mm ²		0.2mm ²			
The minimum area of a wire (AWG)	AWG28		AWG28			
Strip length	8...9mm		8...9mm			

Product	DF20-M-8DO-N	DF20-M-8DO-P	DF20-M-16DO-N	DF20-M-16DO-P	DF20-M-32DO-N	DF20-M-32DO-P
---------	--------------	--------------	---------------	---------------	---------------	---------------

Mechanical Structure

Protection grade	IP20					
Size(H X W X D)	100mm X 12mm X 69mm			100mm X 24mm X 69mm		
Installation type	35mm DIN					

Work Environment

Working temperature	-25...60°C					
Storage temperature	-40...85°C					
Relative humidity	5... 95%RH(non-condensing)					

LED Status Indicator

Channel Light	Green: The output signal of each channel is working.					
---------------	--	--	--	--	--	--

Wiring Diagram

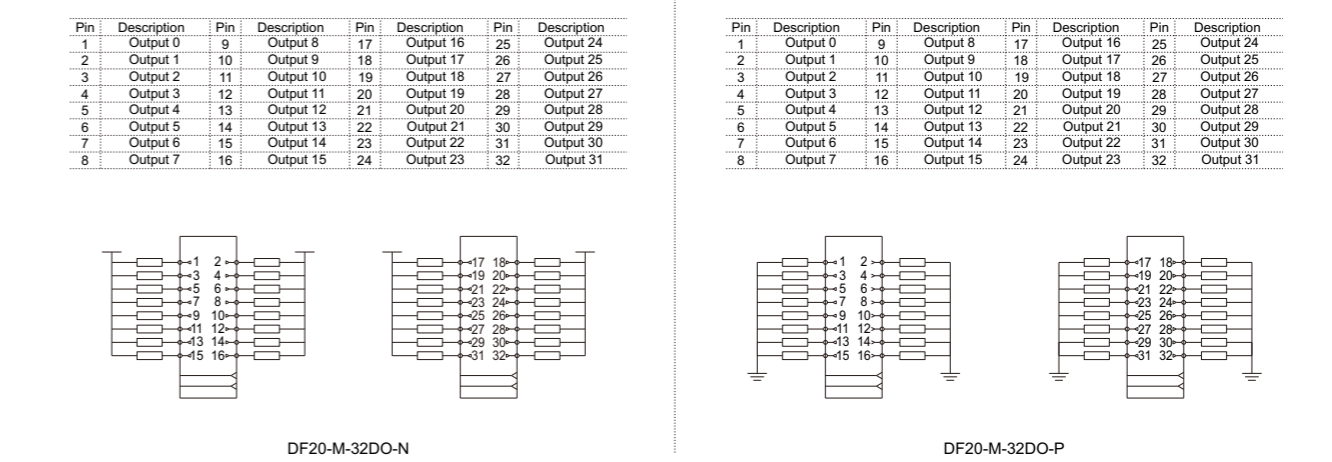
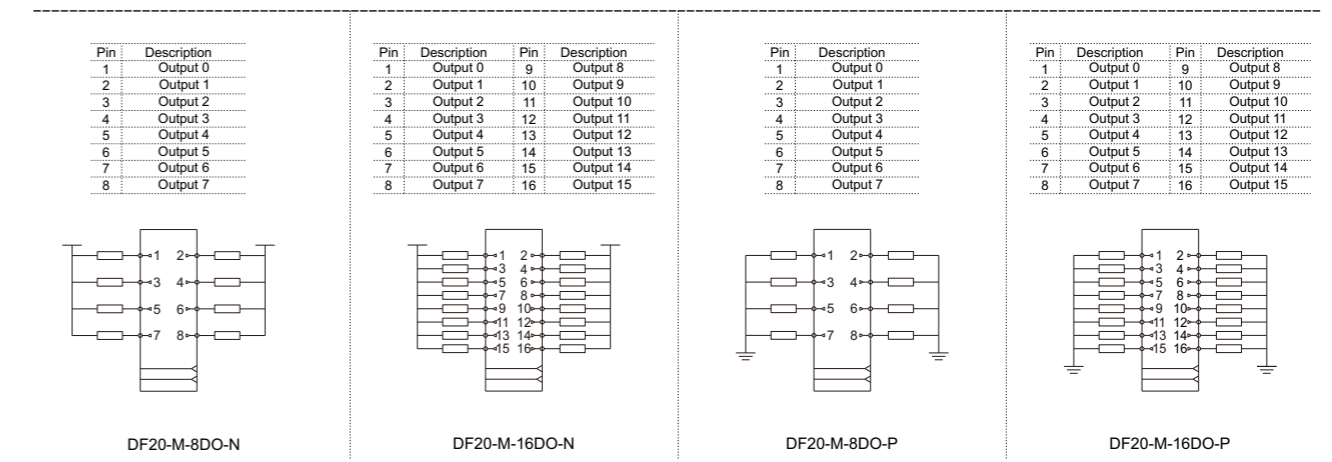

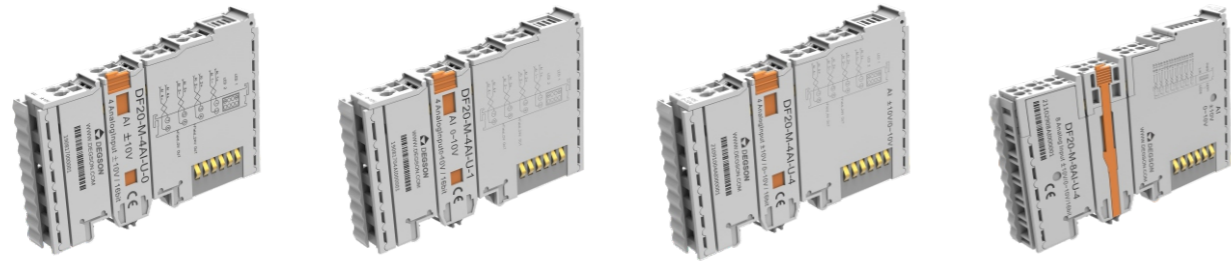

DF20-M-4AI-U-0

DF20-M-4AI-U-1

DF20-M-4AI-U-4

DF20-M-8AI-U-4

Analog input module, 4 ports, -10... 10V, voltage type Analog input module, 4 ports, 0... 10V, voltage type Analog input module, 4 ports, (0...+10V)/(-10...+10V), voltage type Analog input module, 8 ports, (0...+10V)/(-10...+10V), voltage type

Specification				
Product	DF20-M-4AI-U-0	DF20-M-4AI-U-1	DF20-M-4AI-U-4	DF20-M-8AI-U-4
Number of channels	4			8
Data size	8 Byte			16 Byte
Measuring range	Voltage U (-10... 10 V)	Voltage U (0... 10 V)	Voltage U (0...+10V) (-10...+10V)	Voltage U (0...+10V)(-10...+10V)
Signal type	Differential signal			
Connection type	2-line			
Reverse protection	Yes			
Isolation method	Magnetic isolation			
Fault diagnosis	YES			
Internal Resistance	>450KΩ			
Resolution	16 Bit			
Measuring range (Profinet/Ethernet IP)	(-10...+10V): -27648~27648	(0...+10V): 0~27648	(0...+10V): 0~27648 (-10...+10V): -27648~27648	(0...+10V): 0~27648 (-10...+10V): -27648~27648
Measuring range (Others)	(-10...+10V): -32768~32767	(0...+10V): 0~65535	(0...+10V): 0~32767 (-10...+10V): -32768~32767	(0...+10V): 0~32767 (-10...+10V): -32768~32767
Precision	0.20%			
Conversion time	< 1ms			
Sampling rate	20-300Hz (Configuration)			

Power Supply Parameters	
Connection type	Spring terminal blocks
Working voltage	24V DC +20 %/ -15 %
System feed current	<120mA <200mA
Maximum area of wire	2.5mm ² 1.5mm ²
Maximum area of wire (AWG)	AWG14 AWG16
The minimum area of a wire	0.2mm ² 0.2mm ²
The minimum area of a wire (AWG)	AWG28 AWG28
Strip length	8...9mm 8...9mm

Product	DF20-M-4AI-U-0	DF20-M-4AI-U-1	DF20-M-4AI-U-4	DF20-M-8AI-U-4
Mechanical Structure				
Protection grade	IP20			
Size(H X W X D)	100mm X 12mm X 69mm			
Installation type	35mm DIN			
Work Environment				
Working temperature	-25...60°C			
Storage temperature	-40...85°C			
Relative humidity	5... 95%RH(non-condensing)			

LED Status Indicator		
LED1	Green: Power is working	Green: Signal on Channel 1.
LED2	Green blinks: I/O system and modules working properly	Green: Signal on Channel 2.
LED3	—	Green: Signal on Channel 3.
LED4	—	Green: Signal on Channel 4.
LED5	—	Green: Signal on Channel 5.
LED6	—	Green: Signal on Channel 6.
LED7	—	Green: Signal on Channel 7.
LED8	—	Green: Signal on Channel 8.
PWR	—	Green: Power is working.
L/A	—	Green: I/O system and modules working properly.

Wiring Diagram

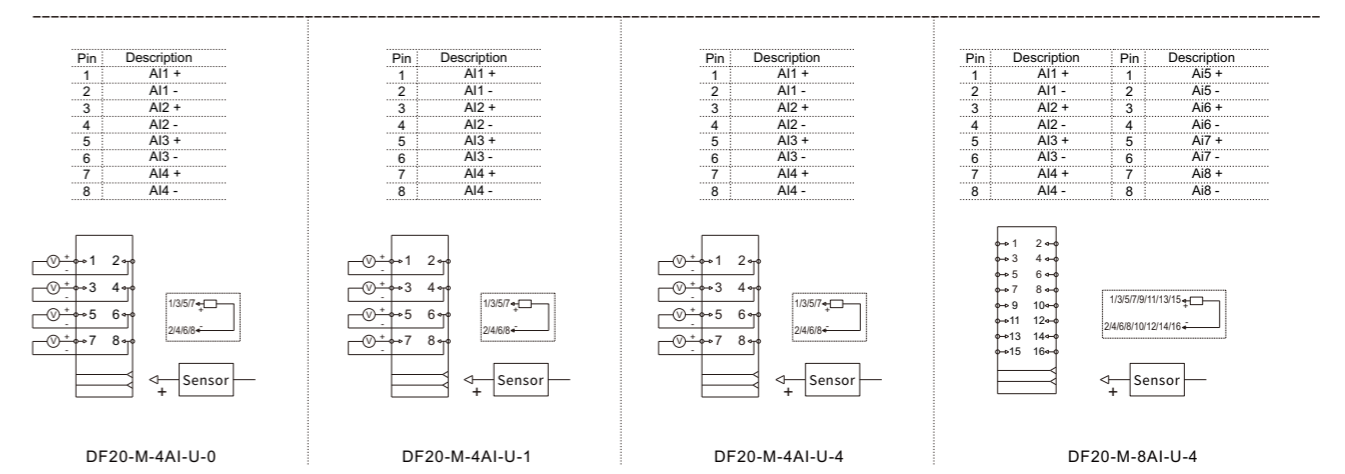

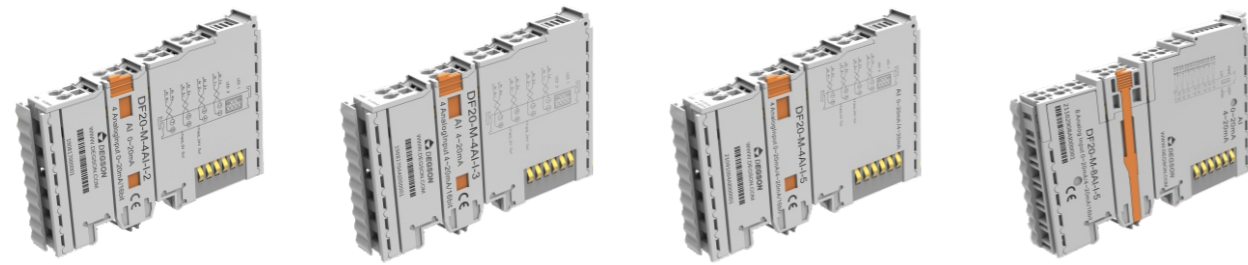

DF20-M-4AI-I-2

DF20-M-4AI-I-3

DF20-M-4AI-I-5

DF20-M-8AI-I-5

Analog input module, 4 ports, 0... 20 mA, current type Analog input module, 4 ports, 4... 20 mA, current type Analog input module, 4 ports, (0...+20mA)(4...+20mA), current type Analog input module, 8 ports, (0...+20mA)(4...+20mA), current type

Specification				
Product	DF20-M-4AI-I-2	DF20-M-4AI-I-3	DF20-M-4AI-I-5	DF20-M-8AI-I-5
Number of channels	4			8
Data size	8 Byte			16 Byte
Measuring range	Current(0..20ma)	Current(4..20ma)	Current I(0...20mA)(4...20mA)	Current I(0...20mA)(4...20mA)
Signal type	Differential signal			
Connection type	2-line			
Reverse protection	Yes			
Isolation method	Magnetic isolation			
Fault diagnosis	YES			
Internal Resistance	100Ω			
Resolution	16 Bit			
Measuring range (Profinet/Ethernet IP)	(0..20ma)0~27648	(4..20ma)0~27648	(0/4..20ma)0~27648	(0/4..20ma)0~27648
Measuring range(Others)	(0..20ma)0~65535	(4..20ma)0~65535	(0/4..20ma)0~65535	(0/4..20ma)0~65535
Precision	0.20%/±50ppm/K max.			
Conversion time	< 1ms			
Sampling rate	20-300Hz (Configuration)			

Power Supply Parameters		
Connection type	Spring terminal blocks	
Working voltage	24V DC +20% / -15%	
System feed current	<120mA	<200mA
Maximum area of wire	2.5mm²	1.5mm²
Maximum area of wire (AWG)	AWG14	AWG16
The minimum area of a wire	0.2mm²	0.2mm²
The minimum area of a wire (AWG)	AWG28	AWG28
Strip length	8...9mm	8...9mm

Product	DF20-M-4AI-I-2	DF20-M-4AI-I-3	DF20-M-4AI-I-5	DF20-M-8AI-I-5
Mechanical Structure				
Protection grade	IP20			
Size(H X W X D)	100mm X 12mm X 69mm			
Installation type	35mm DIN			
Work Environment				
Working temperature	-25...60°C			
Storage temperature	-40...85°C			
Relative humidity	5... 95%RH(non-condensing)			

LED Status Indicator		
LED1	Green: Power is working	Green: Signal on Channel 1.
LED2	Green blinks: I/O system and modules working properly	Green: Signal on Channel 2.
LED3	—	Green: Signal on Channel 3.
LED4	—	Green: Signal on Channel 4.
LED5	—	Green: Signal on Channel 5.
LED6	—	Green: Signal on Channel 6.
LED7	—	Green: Signal on Channel 7.
LED8	—	Green: Signal on Channel 8.
PWR	—	Green: Power is working.
L/A	—	Green: I/O system and modules working properly.

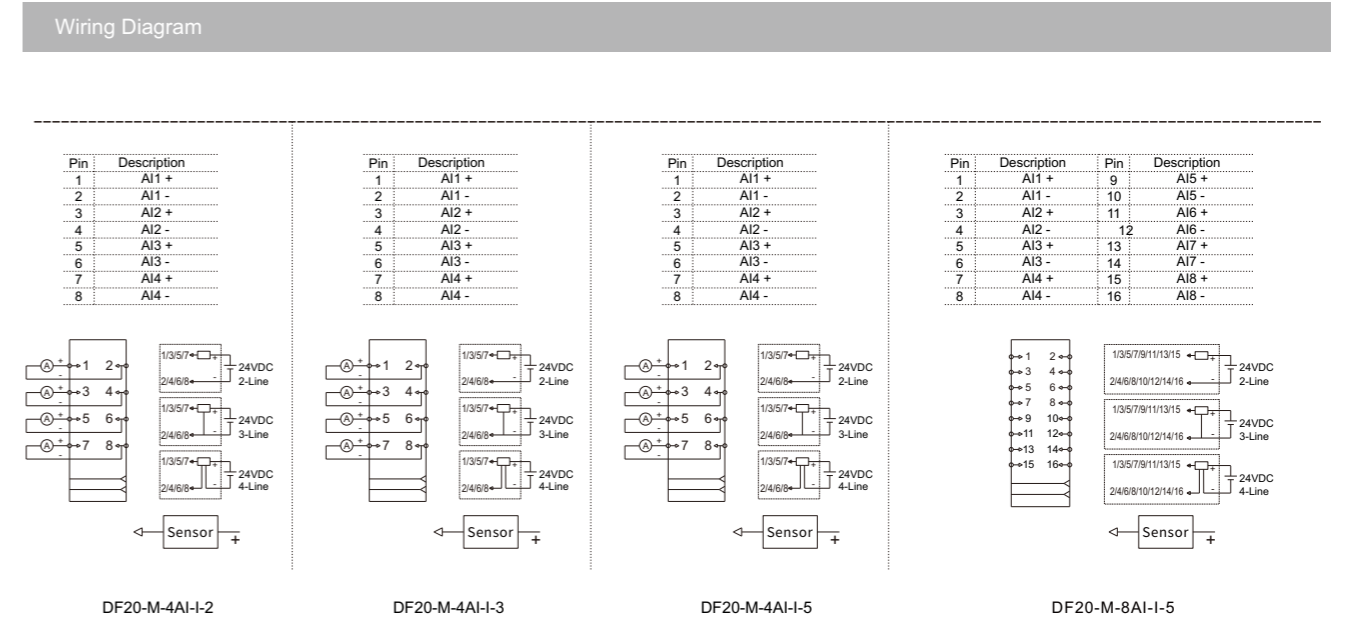

Analog output module

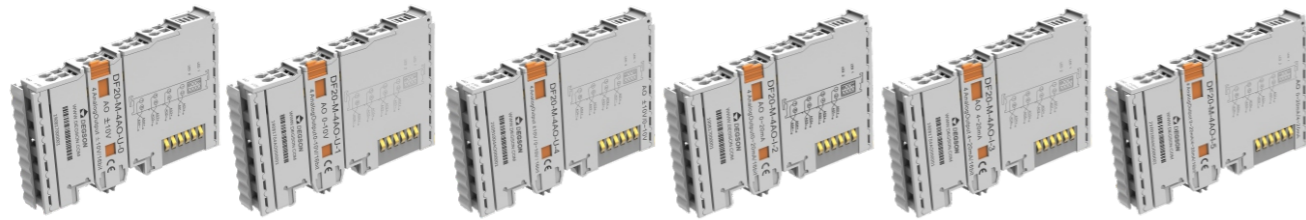

DF20-M-4AO-U-0 DF20-M-4AO-U-1 DF20-M-4AO-U-4 DF20-M-4AO-I-2 DF20-M-4AO-I-3 DF20-M-4AO-I-5

Analog output module, 4 ports, -10...+10V, voltage type	Analog output module, 4 ports, 0...+10V, voltage type	Analog output module, 4 ports, -10...+10V, 0...+10V, voltage type	Analog output module, 4 ports, 0...20 mA, current type	Analog output module, 4 ports, 4...20 mA, current type	Analog output module, 4 ports, 0...20mA, 4...20 mA, current type
---	---	---	--	--	--

Specification

Product	DF20-M-4AO-U-0	DF20-M-4AO-U-1	DF20-M-4AO-U-4	DF20-M-4AO-I-2	DF20-M-4AO-I-3	DF20-M-4AO-I-5
Number of channels	4					
Data size	8 Byte					
Signal type	Differential signal					
Connection type	2-line					
Overcurrent protection	Yes					
Isolation method	Magnetic isolation					
Fault diagnosis	Yes					
Resolution	16 Bit					
Precision	0.10%					
Measuring range (Profinet/Ethernet IP)	(-10...+10V)-27648~27648	(0...+10V):0~27648	(0...+10V): 0~27648 (-10...+10V): -27648~27648	(0..20ma)0~27648	(4..20ma)0~27648	(0/4..20ma)0~27648
Measuring range(Others)	(-10...+10V)-32768~32767	(0...+10V): 0~65535	(0...+10V): 0~32767 (-10...+10V): -32768~32767	(0..20ma)0~65535	(4..20ma)0~65535	(0/4..20ma)0~65535
Temperature coefficient	<20 ppm					
Conversion time	≤ 1ms					
Load impedance	>2KΩ			<250Ω		

Power Supply Parameters

Connection type	Spring terminal blocks					
Working voltage	24V DC +20 %/ -15 %					
System feed current	<200mA			<400mA		
Maximum area of wire	2.5mm ²					
Maximum area of wire (AWG)	AWG14					
The minimum area of a wire	0.2mm ²					
The minimum area of a wire (AWG)	AWG28					
Strip length	8...9mm					

Analog output module



Product	DF20-M-4AO-U-0	DF20-M-4AO-U-1	DF20-M-4AO-U-4	DF20-M-4AO-I-2	DF20-M-4AO-I-3	DF20-M-4AO-I-5
---------	----------------	----------------	----------------	----------------	----------------	----------------

Mechanical Structure

Protection grade	IP20					
Size(H X W X D)	100mm X 12mm X 69mm					
Installation type	35mm DIN					

Work Environment

Working temperature	-25...60°C					
Storage temperature	-40...85°C					
Relative humidity	5... 95%RH(non-condensing)					

LED Status Indicator

LED1	Green : Power is working					
LED2	Green blinks:I/O system and modules working properly					

Wiring Diagram

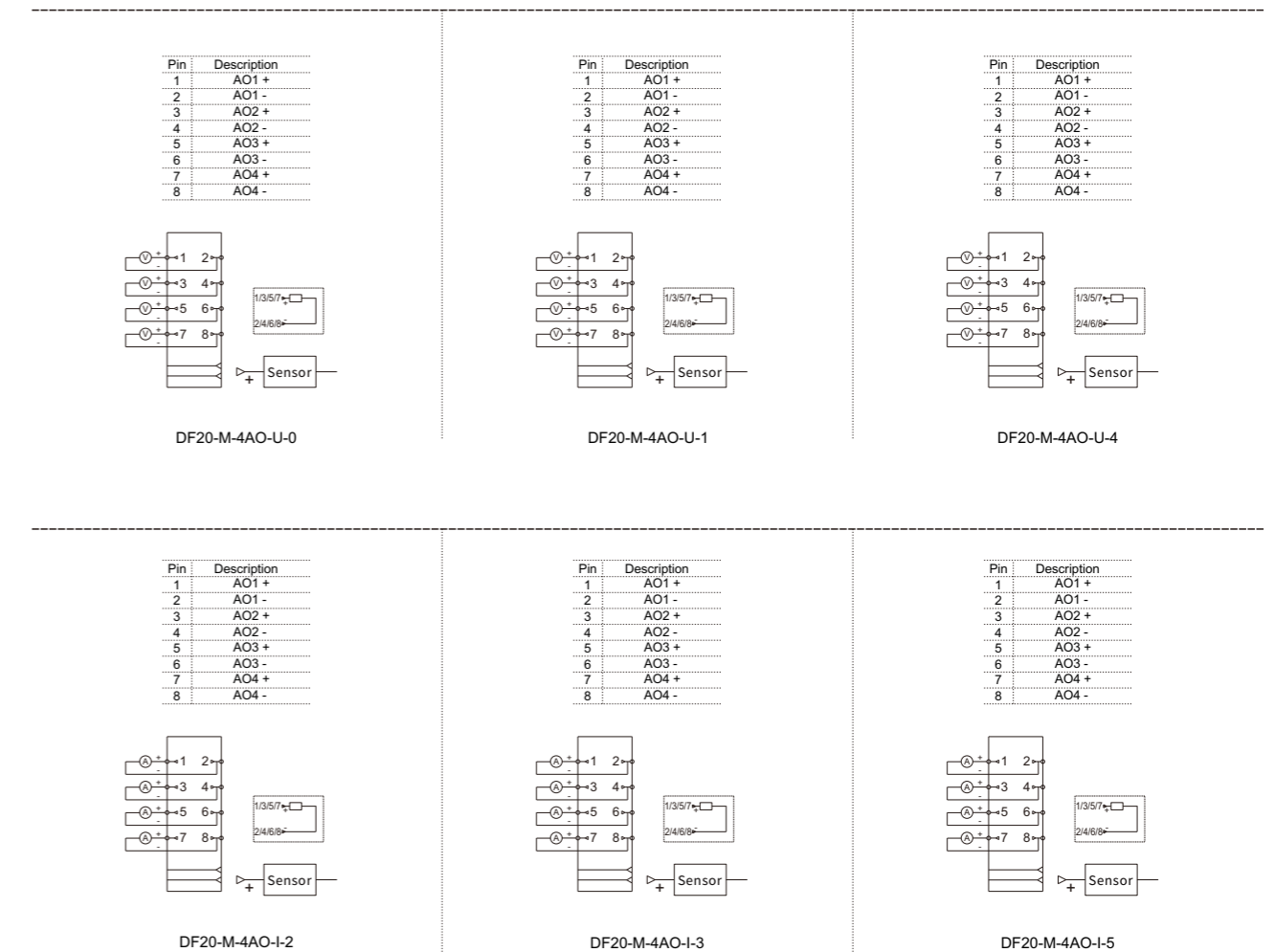

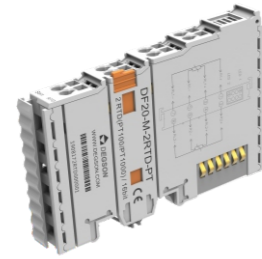

DF20-M-2RTD-PT

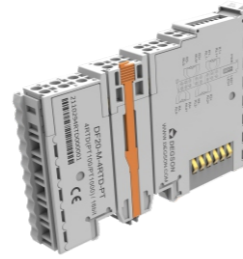
 Thermal Resistance (RTD) measurement module,
16 bit resolution, 2 channels

DF20-M-4RTD-PT

 Thermal Resistance (RTD) measurement module,
16 bit resolution, 4 channels

Specification		
Product	DF20-M-2RTD-PT	DF20-M-4RTD-PT
Number of channels	2	4
Data size	4 Byte	8 Byte
Signal type	Thermal resistance	
Signal type	PT100, PT1000	
Connection type	2/3/4-line	2/3-line
Reverse protection	Yes	
Isolation method	Magnetic isolation	
Fault diagnosis	Yes	
Resolution	16bit, 0.1°C/ each number	
Frequency interference suppression	10Hz 50Hz 60Hz 400Hz	
Diagnosis	Disconnection, Parameter assignment error	
Process alarm	Upper/Lower limit, per channel	
Temperature coefficient	±50ppm/K max.	
Measuring range	-200°C ~ 850°C	
Precision	±0.3%	
Conversion time	150ms	200ms

Product	DF20-M-2RTD-PT	DF20-M-4RTD-PT
Power Supply Parameters		
Connection type	Spring terminal blocks	
Working voltage	24V DC +20 % / -15 %	
System feed current	<60mA	<100mA
Maximum area of wire	2.5mm ²	1.5mm ²
Maximum area of wire (AWG)	AWG14	AWG16
The minimum area of a wire	0.2mm ²	0.2mm ²
The minimum area of a wire (AWG)	AWG28	AWG28
Strip length	8...9mm	8...9mm

Mechanical Structure	
Protection grade	IP20
Size(H X W X D)	100mm X 12mm X 69mm
Installation type	35mm DIN

Work Environment	
Working temperature	-25...60°C
Storage temperature	-40...85°C
Relative humidity	5... 95%RH(non-condensing)

LED Status Indicator	
LED1	Green : Power is working
LED2	Green blinks : I/O system and modules working properly

Wiring Diagram

Pin	Description
1	+R1
2	+R2
3	+RI1
4	+RI2
5	-R1
6	-R2
7	-RI1
8	-RI2

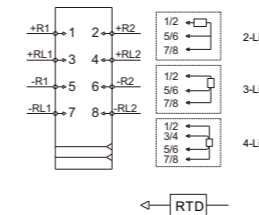

DF20-M-2RTD-PT

Pin	Description	Pin	Description
1	+R1	1	+R3
2	/	2	/
3	-R1	3	-R3
4	-RI1	4	-RI3
5	+R2	5	+R4
6	/	6	/
7	-R2	7	-RI4
8	-R2	8	-R4

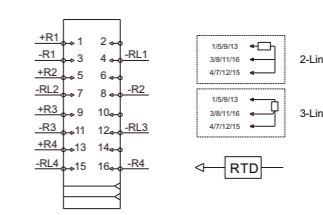

DF20-M-4RTD-PT

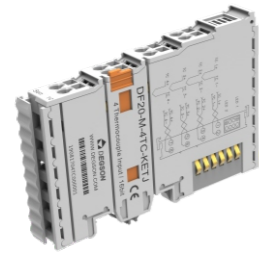

DF20-M-4TC-KETJ

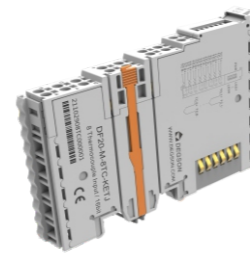
 Thermocouple (TC) module, 4 inputs,
16 bit resolution

DF20-M-8TC-KETJ

 Thermocouple (TC) module, 8 inputs,
16 bit resolution

Specification		
Product	DF20-M-4TC-KETJ	DF20-M-8TC-KETJ
Number of channels	4	8
Data size	8 Byte	16 Byte
Signal type	Thermocouple	
Signal type	E(-30~900°C), J(-210~1200°C) T(-270~400°C), K(-30~1370°C)	
Cold End compensation	Internal and external (accuracy $\leq 3K$)	
Diagnosis	Yes	
Temperature coefficient	≤ 50 ppm/K	
Connection type	2-line	
Reverse protection	Yes	
Isolation method	Magnetic isolation	
Fault diagnosis	Yes	
Internal Resistance	/	
Resolution	16bit, 0.1°C/ resolution	
Frequency interference suppression	10Hz 50Hz 60Hz 400Hz	
Diagnosis	Disconnection, Parameter assignment error	
Process alarm	Upper/Lower limit, per channel	
Temperature coefficient	$\pm 0.5\%$	
Measuring range	-270°C ... +1370°C	
Precision	$\pm 0.3\%$	
Conversion time	125ms	

Product	DF20-M-4TC-KETJ	DF20-M-8TC-KETJ
Power Supply Parameters		
Connection type	Spring terminal blocks	
Working voltage	24V DC +20% / -15%	
System feed current	<70mA	<100mA
Maximum area of wire	2.5mm ²	1.5mm ²
Maximum area of wire (AWG)	AWG14	AWG16
The minimum area of a wire	0.2mm ²	0.2mm ²
The minimum area of a wire (AWG)	AWG28	AWG28
Strip length	8...9mm	8...9mm

Mechanical Structure	
Protection grade	IP20
Size(H X W X D)	100mm X 12mm X 69mm
Installation type	35mm DIN

Work Environment	
Working temperature	-25...60°C
Storage temperature	-40...85°C
Relative humidity	5... 95%RH(non-condensing)

LED Status Indicator	
LED1	Green: Power is working
LED2	Green blinks: I/O system and modules working properly

Wiring Diagram

Pin	Description
1	Signal1 +
2	Signal1 -
3	Signal2 +
4	Signal2 -
5	Signal3 +
6	Signal3 -
7	Signal4 +
8	Signal4 -

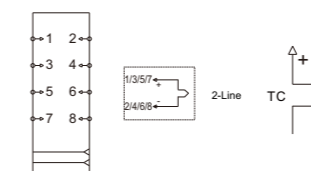

DF20-M-4TC-KETJ

Pin	Description	Pin	Description
1	Signal1 +	9	Signal5 +
2	Signal1 -	10	Signal5 -
3	Signal2 +	11	Signal6 +
4	Signal2 -	12	Signal6 -
5	Signal3 +	13	Signal7 +
6	Signal3 -	14	Signal7 -
7	Signal4 +	15	Signal8 +
8	Signal4 -	16	Signal8 -

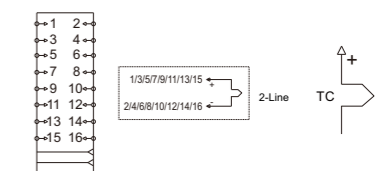

DF20-M-8TC-KETJ



DF20-M-1CNT-EL-4 DF20-M-1CNT-EL-5 DF20-M-1CNT-ELP-5 DF20-M-2CNT-PIL-4 DF20-M-2CNT-PIL-5

Encoder input module, 1 port, 24V Encoder input module, 1 port, 5V Encoder input / pulse output module, 1 port, 5V Pulse counting module, 2 port, 24V Pulse counting module, 2 port, 5V

Specification

Product	DF20-M-1CNT-EL-4	DF20-M-1CNT-EL-5	DF20-M-1CNT-ELP-5	DF20-M-2CNT-PIL-4	DF20-M-2CNT-PIL-5
Maximum frequency count	1Mhz	1Mhz	1Mhz	1Mhz	1Mhz
Number of channels	1			2	
Data size	12 Byte			28 Byte	
Input signal type	Incremental encoder			Pulse signal	
Input signal Voltage	24V DC	5V DC	5V DC	24V DC	5V DC
Input connection type	4-line			2-line	
Output signal type	/	/	422 type	/	/
Reverse protection	Yes				
Isolation method	Magnetic isolation				
Fault diagnosis	Yes				
Resolution	32 Bit				
Precision	±1 pulse				

Power Supply Parameters

Connection type	Spring terminal blocks				
System feed current	<30mA	<30mA	<200mA	<30mA	<30mA
Maximum area of wire	2.5mm ²				
Maximum area of wire (AWG)	AWG14				
The minimum area of a wire	0.2mm ²				
The minimum area of a wire (AWG)	AWG28				
Strip length	8...9mm				

Product	DF20-M-1CNT-EL-4	DF20-M-1CNT-EL-5	DF20-M-1CNT-ELP-5	DF20-M-2CNT-PIL-4	DF20-M-2CNT-PIL-5
---------	------------------	------------------	-------------------	-------------------	-------------------

Mechanical Structure

Protection grade	IP20				
Size(H X W X D)	100mm X 12mm X 69mm				
Installation type	35mm DIN				

Work Environment

Working temperature	-25...60°C				
Storage temperature	-40...85°C				
Relative humidity	5... 95%RH(non-condensing)				

LED Status Indicator

LED1	Green : Power is working				
LED2	Green blinks:I/O system and modules working properly				

Wiring Diagram

Pin	Description	Notes
1	24V	NPN:1=24V,2=signal
2	0V	PNP:1=signal,2=0V
3	ENCA+ / ENCA	
4	ENCA- / 0V	
5	ENCB+ / ENCB	
6	ENCB- / 0V	
7	PE	
8	PE	

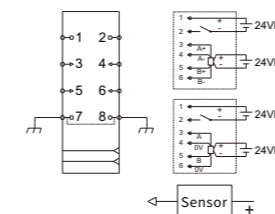

DF20-M-1CNT-EL-4

Pin	Description	Notes
1	24V	NPN:1=24V,2=signal
2	0V	PNP:1=signal,2=0V
3	ENCA+ / ENCA	
4	ENCA- / 0V	
5	ENCB+ / ENCB	
6	ENCB- / 0V	
7	PE	
8	PE	

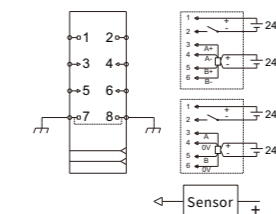

DF20-M-1CNT-EL-5

Pin	Description	Notes
1	24V	NPN:1=24V,2=signal
2	0V	PNP:1=signal,2=0V
3	ENCA+ / ENCA	
4	ENCA- / 0V	
5	ENCB+ / ENCB	
6	ENCB- / 0V	
7	RS422_TR_out+	
8	RS422_TR_out-	

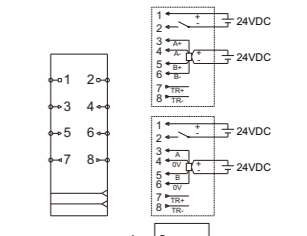

DF20-M-1CNT-ELP-5

Pin	Description	Notes
1	24V	NPN:1=24V,2=signal
2	0V	PNP:1=signal,2=0V
3	Signal1_24V	
4	Signal1	
5	24V	NPN:5=24V,6=signal
6	0V	PNP:5=signal,6=0V
7	Signal2_24V	
8	Signal2	

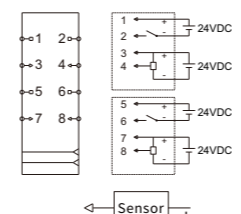

DF20-M-2CNT-PIL-4

Pin	Description	Notes
1	24V	NPN:1=24V,2=signal
2	0V	PNP:1=signal,2=0V
3	Signal1_24V	
4	Signal1	
5	24V	NPN:5=24V,6=signal
6	0V	PNP:5=signal,6=0V
7	Signal2_24V	
8	Signal2	

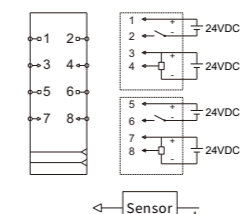

DF20-M-2CNT-PIL-5

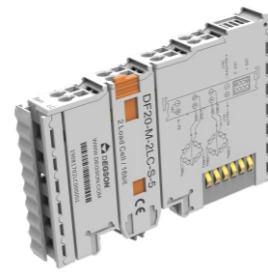

DF20-M-2LC-S-5

Bridge measurement module, 16-bit resolution, 2-channel

Specification	
Product	DF20-M-2LC-S-5
Measuring range	0-10mV
Number of channels	2
Signal type	Load Cell/Bridge, pressure sensor, Load Cell
Connection type	4-line
Reverse protection	Yes
Isolation method	Magnetic isolation
Data size	8 Byte
Fault diagnosis	Yes
Internal Resistance	>500KΩ
Resolution 16bit	16bit
Frequency interference suppression	10Hz 50Hz 60Hz 400Hz
Diagnosis	Parameter assignment error
Precision	0.20%
Measuring range	-32768~32767
Conversion time	3.3ms
Power Supply Parameters	
Connection type	Spring terminal blocks
Working voltage	24V DC +20% / -15%
System feed current	<210mA
Maximum area of wire	2.5mm ²
Maximum area of wire (AWG)	AWG14
The minimum area of a wire	0.2mm ²
The minimum area of a wire (AWG)	AWG28
Strip length	8...9mm

Product	DF20-M-2LC-S-5
Mechanical Structure	
Protection grade	IP20
Size(H X W X D)	100mm X 12mm X 69mm
Installation type	35mm DIN
Work Environment	
Working temperature	-25...60°C
Storage temperature	-40...85°C
Relative humidity	5... 95%RH(non-condensing)
LED Status Indicator	
LED1	Green: Power is working
LED2	Green blinks: I/O system and modules working properly
Wiring Diagram	

Pin	Description
1	Ref power 5V
2	Ref power 0V
3	Signal1 +
4	Signal1 -
5	Signal2 +
6	Signal2 -
7	PE
8	PE

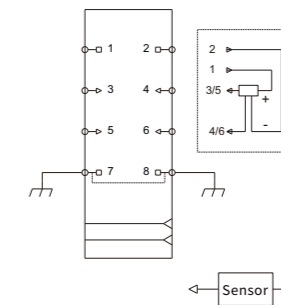

DF20-M-2LC-S-5

Voltage distribution module



DF20-M-DC-U-5

Voltage distribution module, 24VDC to 5VDC

DF20-M-DC-U-24

Voltage distribution module, 16 channel 24VDC

DF20-M-DC-U-0

Voltage distribution module, 16 channel 0VDC

DF20-M-T-8L

Extended module, 8channel, 2 line

DF20-M-DC-UD-5

Voltage distribution module, 24VDC to 5VDC

Specification

Product	DF20-M-DC-U-5	DF20-M-DC-U-24	DF20-M-DC-U-0	DF20-M-T-8L	DF20-M-DC-UD-5
Number of channels	1	16	16	8	1
Isolation method	Electrical isolation	/	/	/	/

Power Supply Parameters

Connection type	Spring terminal blocks	Spring terminal blocks	Spring terminal blocks	Spring terminal blocks	Spring terminal blocks
Working voltage	24V DC +20 %/ -15 %	24V DC +20 %/ -15 %	0V DC	0V...36VDC	24V DC +20 %/ -15 %
Reverse power protection	YES		/		YES
Supply system voltage	5VDC		/		5VDC
Supply system current	Max.0.75A		/		Max.2A
Supply load voltage	24V DC +20 %/ -15 %	24V DC +20 %/ -15 %	0VDC	Voltage distribution	24V DC +20 %/ -15 %
Supply load current (MAX)	5A		5A		8A
Maximum area of wire	2.5mm ²		1.5mm ²		2.5mm ²
Maximum area of wire (AWG)	AWG14		AWG16		AWG14
The minimum area of a wire	0.2mm ²		0.2mm ²		0.2mm ²
The minimum area of a wire (AWG)	AWG28		AWG28		AWG28
Strip length	8...9mm		8...9mm		8...9mm

Voltage distribution module

Product	DF20-M-DC-U-5	DF20-M-DC-U-24	DF20-M-DC-U-0	DF20-M-T-8L	DF20-M-DC-UD-5
Mechanical Structure					
Protection grade	IP20				
Size(H X W X D)	100mm X 12mm X 69mm				
Installation type	35mm DIN				
Work Environment					
Working temperature	-25...60°C				
Storage temperature	-40...85°C				
Relative humidity	5...95%RH(non-condensing)				

LED Status Indicator

POWER-1, POWER-2	Green: The system power is working.	/	Green: The system power is working.
POWER-7, POWER-8	Green: The load power is working.	/	Green: The load power is working.

Wiring Diagram

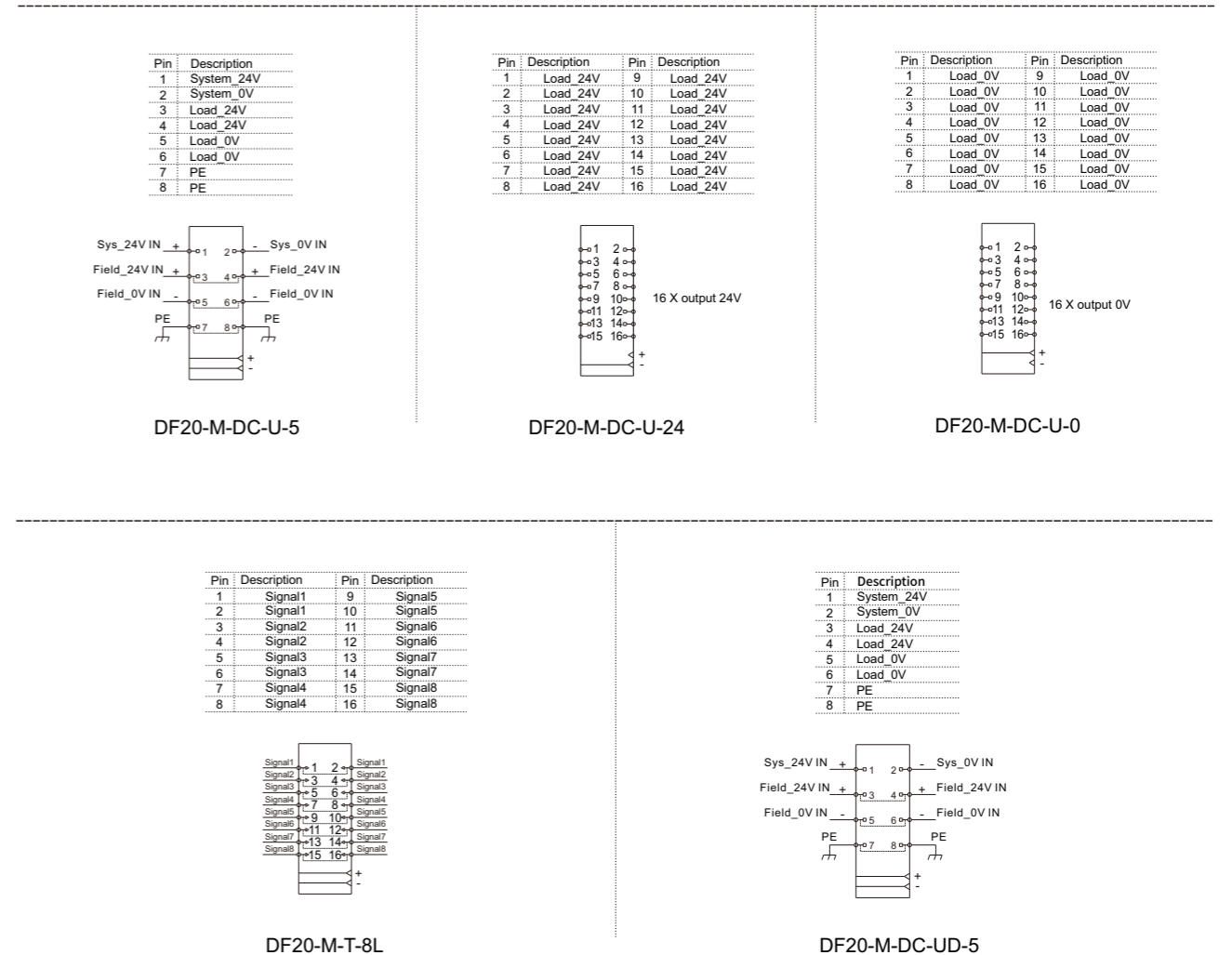



DSW-A3K



DSW-A5K



DSW-A8K

Features

- Industrial-grade Chip.
- 10/100/1000 BaseT(X)(RJ45 connector) .
- Compact size for easy installation.
- Broadcast storm protection (BSP),the Quality of Service (QoS) function.
- Die-casting aluminum alloy housing.
- IP30 protection class.
- -40 to 75°C wide operating temperature range.

Specifications

Type	DSW-A5K0005	DSW-A8K0008	DSW-A3K1020	DSW-A5K0050	DSW-A8K0080	DSW-A5K0104	DSW-A8K0206	DSW-A8K0107
Ports	5 BaseT ports	8 BaseT ports	1BaseX SFP port 2 BaseT ports	5 BaseT ports	8 BaseT ports	1 BaseX SFP port 4 BaseT ports	2 BaseX SFP port 6 BaseT ports	1 BaseX SFP port 7 BaseT ports
Bandwidth	100M	100M	1000M	1000M	1000M	100M	100M	100M

Switch Properties

Processing Type	Store-and-Forward
Backplane Bandwidth	16Gbps (Max)
MAC Table Size	4K (Max)
Packet Buffer Size	1.5Mb (Max)

DIP Switch Configuration

	Quality of Service (QoS), Broadcast Storm Protection (BSP)
	Ethernet Interface

Power Parameters

Connection	1 removable 2-contact terminal block
Input Voltage	12/24/48 VDC & 24 VAC
Operating Voltage	9.6~60 VDC & 18~30 VAC
Overload Current Protection	Supported
Reverse Polarity Protection	Supported

Physical Characteristics

Installation	DIN-rail mounting
Housing	Die-casting aluminum alloy housing
(W×H×D) Dimensions	MTX100-A3K/-A5K: 24mm x 100mm x 61.8mm MTX100-A8K: 40mm x 100mm x 61.8mm
Weight	0.23Kg (Max)
Power Consumption	5W(Max)

Environment Limits

Ambient Relative Humidity	5 to 95% (non-condensing)
Operating Temperature	- 40°C~ 75°C
Storage Temperature	- 40°C~ 85°C

Standards and Certifications

Safety	IEC/EN62368-1
FCC	FCC 47 CFR Part 15 Class A
EMC	EN55032 EN55035

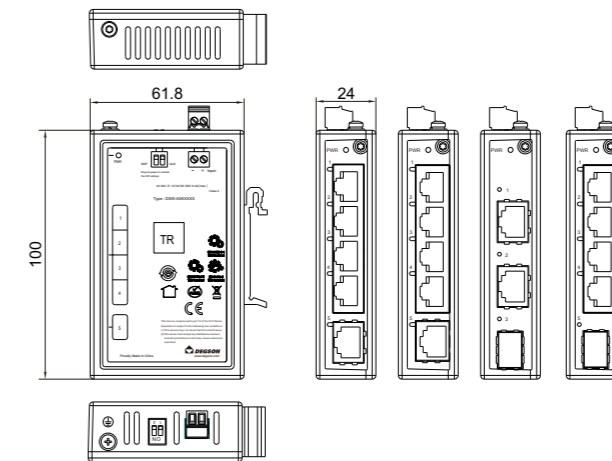
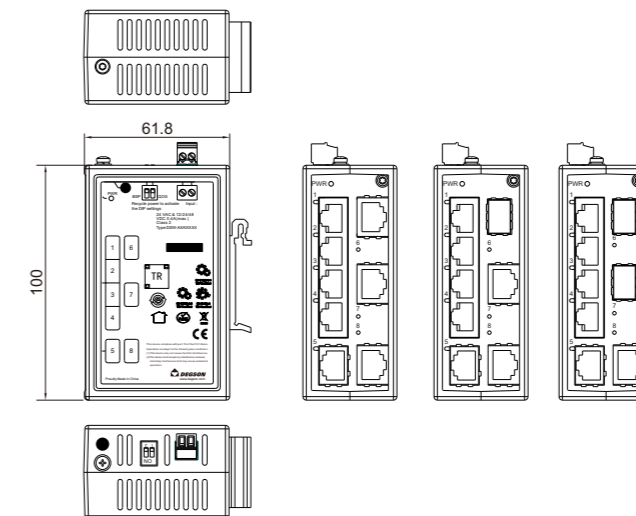
Overall Dimensions
DSW-A3K/A5K

DSW-A8K

Accessories

Picture	Product	Transmission rate	Transfer mode	Matching model
	DSW-SFP-01-S-20	10/100Mbps	Single mode	DSW-A5K0104 DSW-A8K0107 DSW-A8K0206
	DSW-SFP-10-S-20	100/1000Mbps	Single mode	DSW-A3K1020



DSW-A16K000G

Features

- Industrial-grade Chips
- Small size, and easy to install
- Support QoS (IEEE 802.1P/1Q and TOS/DiffServ)
- Die-cast aluminum alloy shell
- IP30 protection grade
- Redundant dual input power supply design
- -40 to 75°C wide operating temperature range
- Support DIP sound and light alarm output and 1 relay alarm port (1A@24VDC)

Specifications	
Type	DSW-A16K000G
Ports	16 16 BaseT ports
Bandwidth	100M
Switch Properties	
Processing Type	Store-and-Forward
Backplane Bandwidth	8.8Gbps (Max)
MAC Table Size	8K (Max)
Packet Buffer Size	4Mb (Max)
DIP Switch Configuration	
DIP Switch Function	QoS (Quality of Service), BSP (Broadcast Storm Protection), Power Alarm, Port Alarm, Alarm Buzzer
Power Parameters	
Connection	1 removable 6- contact terminal block
Input Voltage	12/24/48 VDC & 24 VAC, redundant dual input
Operating Voltage	9.6-60 VDC & 18-30 VAC
Overload Current Protection	Supported
Reverse Polarity Protection	Supported
Power Consumption	<10W
Physical Characteristics	
Installation	DIN-rail mounting
Housing	Die-casting aluminum alloy housing
IP Grade	IP30
(W×H×D) Dimensions	52mmx140mmx110mm
Weight	<1.2 kg
Environment Limits	
Ambient Relative Humidity	5 to 95% (non-condensing)
Operating Temperature	-40°C~ 75°C
Storage Temperature	-40°C~ 85°C
Standards and Certifications	
Safety	IEC/EN62368-1
FCC	FCC:FCC 47 CFR Part 15 Class A
EMC	EN55032 EN55035

Overall Dimensions

DSW-A16K000G

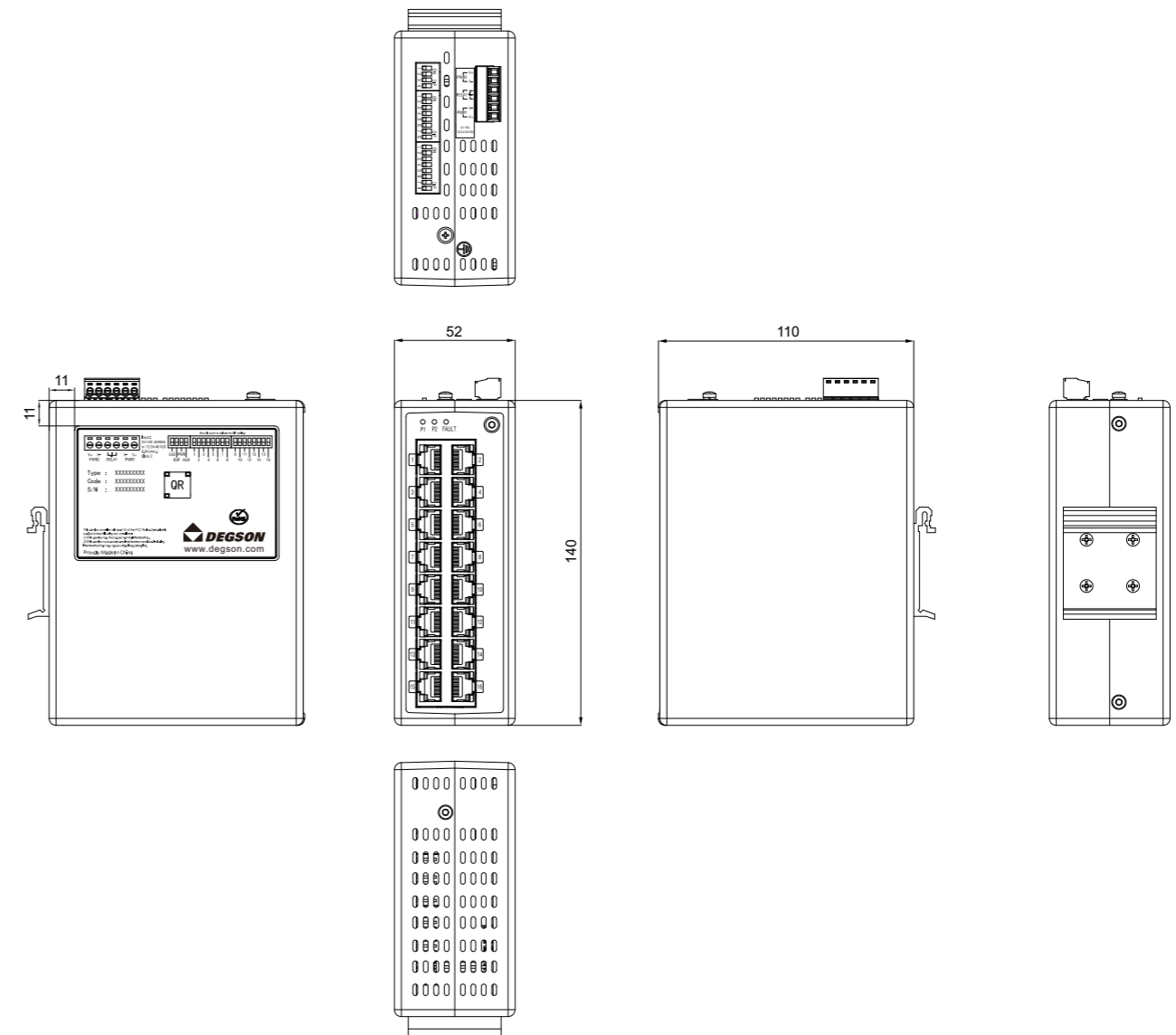

Accessories				
Picture	Product	Transmission rate	Transfer mode	Matching model
/	/	/	/	/
/	/	/	/	/



DSW-A6K2040P



DSW-A10K2080P

Features

- Full Gigabit Ethernet ports.
- 20Gbps backplane bandwidth.
- Support IEEE 802.3af/at compliant PoE.
- Each PoE port provides up to 30W output power
- PoE management: PoE device detection, PoE power management.
- Dual redundant power inputs design for DC models.
- IP40 Die-casting aluminum alloy housing.
- Fanless, -40 to 75°C wide operating temperature range.
- MTBF \geq 400,000 hours.

Specifications

Type	DSW-A6K2040P	DSW-A10K2080P
Ports	2 BaseX SFP port, 4 BaseT ports	2 BaseX SFP port, 8 BaseT ports
Bandwidth	1000M	1000M

Switch Properties

Processing Type	Store-and-Forward
Backplane Bandwidth	20Gbps (Max)
MAC Table Size	4K (Max)
Exchange Rate	1,488,000 pps / 1000M ports

Power Parameters

Connection	1 removable 5-contact terminal block
Input Voltage	DSW-A6K/A10K: 48-57VDC, Redundant dual inputs
Overload Current Protection	Supported
Reverse Polarity Protection	Supported

Physical Characteristics

Installation	DIN-rail mounting, Wall mounting
Housing	Die-casting aluminum alloy housing
Protection level	IP30
(W×H×D) Dimensions	52mm×140mm×110mm
Weight	0.7 kg
MTBF	>400,000H

Environment Limits

Ambient Relative Humidity	5 to 95% (non-condensing)
Operating Temperature	-40°C~75°C
Storage Temperature	-40°C~85°C

Electromagnetic Characteristics

EMI	FCC 47 CFR Part 15 Class A EN55022 Class A
-----	--

Standards and Certifications

Safety	FCC Part 15 Subpart B Class A	IEC/EN55022 Class A IEC60825-1
Industrial Control Industry	UL/cUL61010	
Power Industry	IEC61850-3 IEEE1613 (C37.90.x)	

Overall Dimensions

DSW-A6K2040P

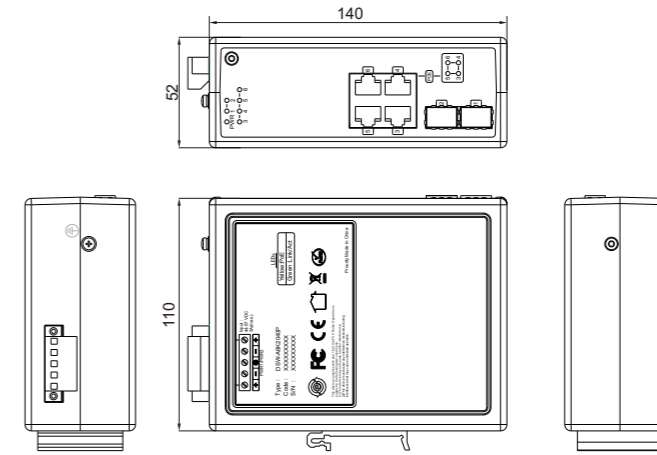

DSW-A10K2080P

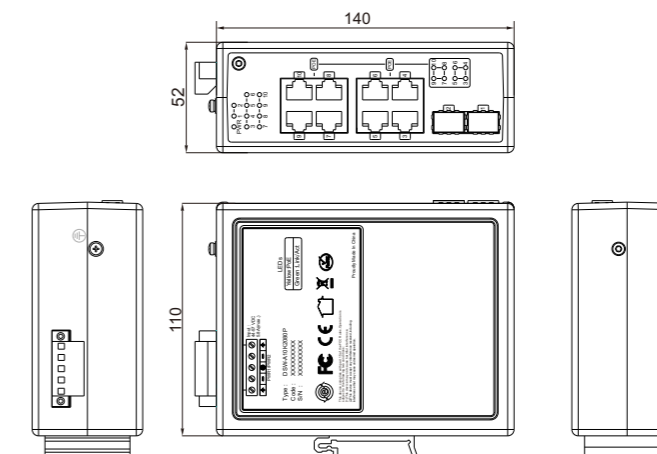

Accessories

Picture	Product	Transmission rate	Transfer mode	Matching model
	DSW-SFP-10-S-20	100/1000Mbps	Single mode	DSW-A6K2040P DSW-A10K2080P
/	/	/	/	/



DPE1-75W-D24-01A(H) DPE1-120W-D24-01A(H)

Features

- Wide input voltage range: 90-264VAC / 120-370VDC.
- Operating temperature range: -30 °C - +70 °C.
- 4000vac high isolation voltage.
- Low ripple noise.
- Output short circuit, overcurrent, overpressure and over temperature protection.
- Can be installed on ts-35/7.5/15.

Specification

Product Name	DPE1-75W-D24-01A(H)	DPE1-120W-D24-01A(H)
Input Parameter		
Input voltage range	Single Phase, 90... 264 VAC/127... 370 VDC	
Input frequency range	47...63Hz	
Input Current	2A (115Vac) 1A (230Vac)	2.7A (115Vac) 1.6A (230Vac)
Power consumption	<1W	
Connection Mode	PCB universal screw terminal blocks	
Output Parameter		
Output efficiency	89% (230Vac@24V/3.2A, 25°C)	88% (230Vac@24V/5A, 25°C)
Output rated voltage	24VDC ±1%	
Range of output voltage	24...28VDC	
Output rated current	3.2A	5A
Rated power	76.8W	120W
Voltage Ripple (20MHz)	< 120mVp-p	
Load variation and current slope	10%~100%, 0.032A/μs	10%~100%, 0.05A/μs
Rise time	<3000ms	
Capacitive load	1500μF	1200μF
Dynamic recovery time	≤1ms	
Linear rate of adjustment	±0.5%	
Load regulation	±1%	
Impulse current	25A (115Vac) 45A (230Vac)	30A (115Vac) 55A (230Vac)
Leakage current	<0.5mA (240Vac)	
Coefficient of temperature drift	±0.03% / °C	
Power-down hold time	12ms (115Vac) 60ms (230Vac)	8ms (115Vac) 16ms (230Vac)
Switching frequency	65KHZ	
Connection Mode	PCB universal screw terminal blocks	

Mechanical Parameter		
Size (L X W X D)	87.5 x 32 x 125 mm	100 x 36 x 125 mm
Weight	0.35 kg	0.41 kg
Shell material	Metal (Al1100, SGCC)	
DC light	YES	
Environmental Parameter		
Working temperature	-30°C to +70°C	-20°C to +60°C
Storage temperature	-40°C to +85°C	
Storage humidity	10...95%	
Working Humidity	20...90%	
Impact test	IEC 60068-2-27(bearing 30G)	
Vibration test	IEC 60068-2-6(X, Y, Z axis, 2g)	
Pollution level	2	
Operational altitude	0-2000m	

Security Parameter	
Overcurrent protection range	105%... 150%, which can be recovered automatically after the abnormal load conditions are removed
Overvoltage protection	≤ 33V (output voltage off, input restart recovery)
Overheat protection	The output voltage is turned off, the abnormal over temperature is removed and the output can be restored after the power is restarted
Short circuit protection	Can be short-circuited for long periods of time, self-recovery
Safety Standard	IS13252(Part1) & EN62368-1
Security level	CLASS I
Mean Time between failures	> 300,000 hours

Dimensional Drawing

DPE1-75W-D24-01A(H) DPE1-120W-D24-01A(H)

Wiring Diagram

DPE1-75W-D24-01A(H)
DPE1-120W-D24-01A(H)



DPS1-120W-D24-01A(H)

DPS1-240W-D24-01A(H)

DPS1-480W-D24-01A(H)

Features

- Wide Input Voltage Range: 100-260VAC/120-370VDC .
- Operating temperature range: -30 °C-+ 70 °C .
- Efficiency up to 94% .
- DC OK function.
- Active PFC 150% .
- Peak power sustainable 1s output.
- Output short-circuit, overcurrent, overpressure, over temperature protection.
- Can be installed on TS-35/7.5/15.

Specification

Output rated voltage	DPS1-120W-D24-01A(H)	DPS1-240W-D24-01A(H)	DPS1-480W-D24-01A(H)
Input Parameter			
Input voltage range	Single Phase, 100... 240 VAC/100... 370 VDC	Single Phase, 100... 240 VAC/120... 370 VDC	Single Phase, 85... 264 VAC/120... 370 VDC
Input frequency range	47...63Hz		
Input Current	1.5A (115Vac) 0.75A (230Vac)	3A (115Vac) 1.5A (230Vac)	5A (115Vac) 2.5A (230Vac)
Power consumption	<2W	<4W	<8W
Connection Mode	PCB universal screw terminal blocks		
Output Parameter			
Output efficiency	94% (230Vac@24V/5A, 25°C)	94% (230Vac@24V/5A, 25°C)	94% (230Vac@24V/5A, 25°C)
Output rated voltage	24VDC ±1%	24VDC ±1%	24VDC ±1%
Range of output voltage	23.5VDC...28VDC	23.5VDC...28VDC	23.5VDC...28VDC
Output rated current	5A	10A	20A
Rated power	120W	240W	480W
Voltage Ripple (20MHz)	< 100mVp-p	< 120mVp-p	< 100mVp-p
Load variation and current slope	10%~100%, 0.05A/μs	10%~100%, 0.05A/μs	10%~100%, 0.05A/μs
Rise time	≤1000ms	≤3000ms	≤3000ms
Capacitive load	50000μF	40000μF	2700μF
Power factor	0.98 (115Vac) 0.94 (230Vac)	0.98 (115Vac) 0.94 (230Vac)	0.99 (115Vac) 0.95 (230Vac)
Startup delay time	≤1000ms	≤3000ms	≤3000ms
Dynamic recovery time	≤1ms	≤1ms	≤1ms
Linear rate of adjustment	±0.5%	±0.5%	±0.5%
Load regulation	±1%	±1%	±1%
Impulse current	15A (115Vac) 30A (230Vac)	15A (115Vac) 30A (230Vac)	20A (115Vac) 40A (230Vac)
Leakage current	< 1mA (240Vac)	< 0.5mA (240Vac)	< 0.8mA (240Vac)
Coefficient of temperature drift	±0.03% / °C	±0.03% / °C	±0.03% / °C
Power-down hold time	20ms	20ms	20ms
Switching frequency	100KHZ	100KHZ	100KHZ
Connection Mode	PCB universal screw terminal blocks		

Mechanical Parameter

Size (L X W X D)	110 x 32 x 124 mm	110 x 41 x 124 mm	131.5 x 48 x 125 mm
Weight	0.49 kg	0.65 kg	0.98 kg
Shell material	Metal (Al1100, SGCC)		
DC light	YES		

Environmental Parameter

Working temperature	-40°C to + 70°C	-30°C to + 70°C
Storage temperature	-40°C to + 85°C	
Storage humidity	10...95%	
Working Humidity	20...90%	
Impact test	IEC 60068-2-27(bearing 30G)	
Vibration test	10~500hz, 5g, 10 minutes / cycle	
Pollution level	2	
Operational altitude	5000m	2000m

Security Parameter

Overcurrent protection range	105% ... 150% , automatically recovers after the abnormal load condition is removed		
Overvoltage protection	≤ 33V (output voltage off, input restart recovery)		
Overheat protection	Start temperature: 90 °C, release temperature: 60 °C	Start temperature: 80 °C, release temperature: 60 °C	Start temperature: 90 °C, release temperature: 60 °C
Short circuit protection	Can be short-circuited for long periods of time, self-recovery		
Safety Standard	UL61010-1 & UL61010-2-201 & EN62368-1		
Security level	CLASS I		
Mean Time between failures	> 300,000 hours		

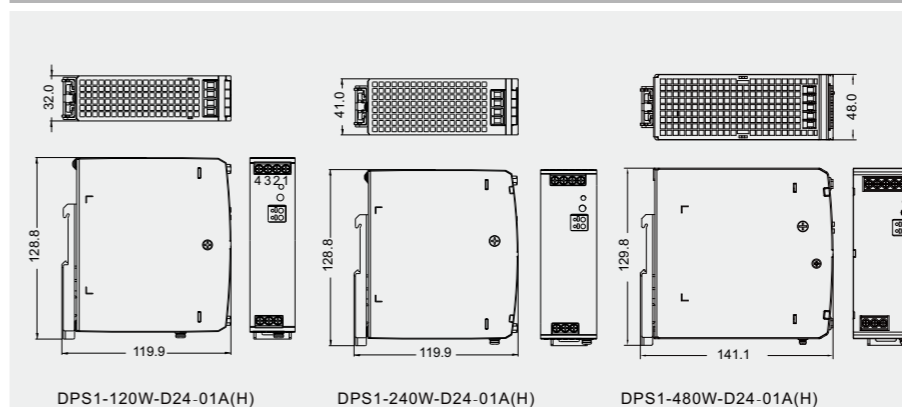
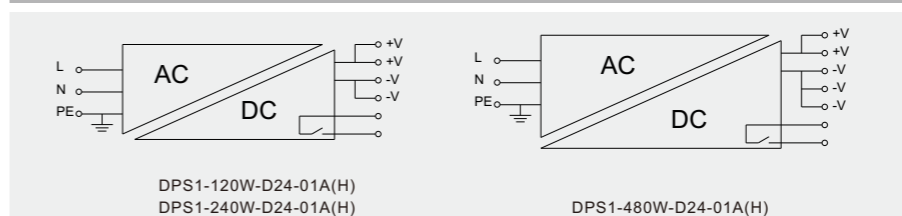
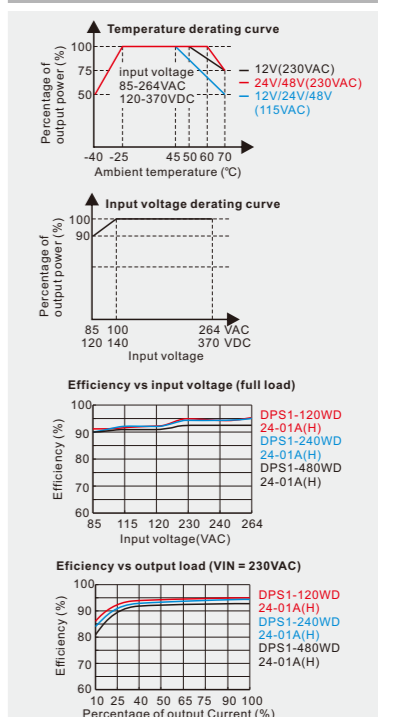
Dimensional Drawing

Wiring Diagram

Product Characteristic Curve



DRPS-1C-D24-06A(H)



DPSF05A-E1-00A(H)



DRPS-1C-D60-06A(H)



DPSF05B-E1-00A(H)

DRPS series				
Technical parameter	Relay	Base	Accessory	Assembled module
24DC/1CO/6A	DRPS-1C-D24-06A(H)	DPSF05A-E1-00A(H)	/	/
220AC/1CO/6A	DRPS-1C-D60-06A(H)	DPSF05B-E1-00A(H)	/	/

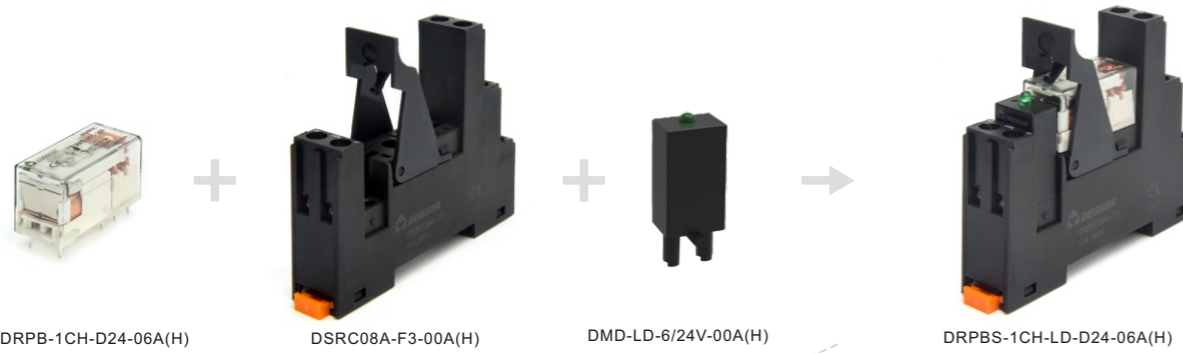

DRPB-1CH-D24-06A(H)



DSRC08A-F3-00A(H)



DMD-LD-6/24V-00A(H)



DRPBS-1CH-LD-D24-06A(H)

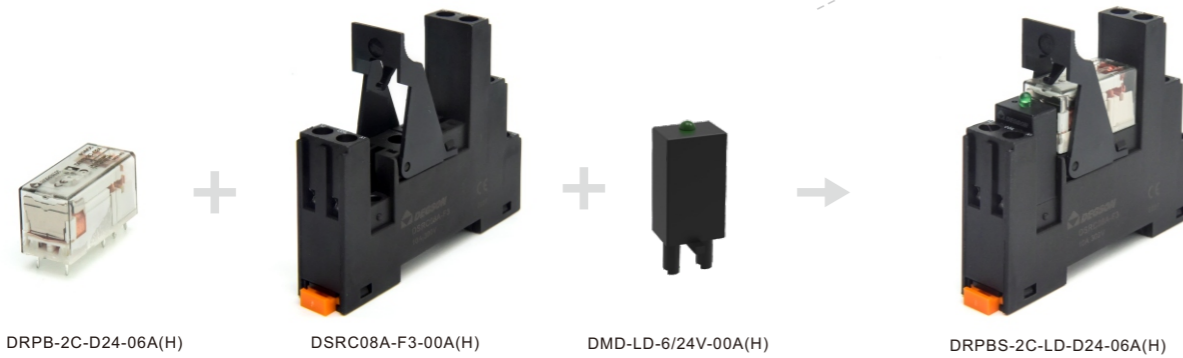

DRPB-2C-D24-06A(H)



DSRC08A-F3-00A(H)



DMD-LD-6/24V-00A(H)



DRPBS-2C-LD-D24-06A(H)

DRPB series				
Technical parameter	Relay	Base	Accessory	Assembled module
24DC/1CO/16A	DRPB-1CH-D24-06A(H)	DSRC08A-F3-00A(H)	DMD-LD-6/24V-00A(H)	DRPBS-1CH-LD-D24-06A(H)
24DC/2CO/8A	DRPB-2C-D24-06A(H)	DSRC08A-F3-00A(H)	DMD-LD-6/24V-00A(H)	DRPBS-2C-LD-D24-06A(H)



DRPT-1C-LR-D24-02A(H)



DSRT05A-E3-00A(H)



DRPTP-1C-D24-02A(H)



DRPT-1C-LR-A220-02A(H)



DSRT05A-E3-00A(H)



DRPTP-1C-A220-02A(H)

DRPT series				
Technical parameter	Relay	Base	Accessory	Assembled module
24DC/1CO/12A	DRPT-1C-LR-D24-02A(H)	DSRT05A-E3-00A(H)	/	DRPTP-1C-D24-02A(H)
220AC/1CO/12A	DRPT-1C-LR-A220-02A(H)	DSRT05A-E3-00A(H)	/	DRPTP-1C-A220-02A(H)



DRPT-2C-LR-D24-02A(H)



DSRT08A-E3-00A(H)



DRPTP-2C-D24-02A(H)



DRPT-2C-LR-A220-02A(H)



DSRT08A-E3-00A(H)



DRPTP-2C-A220-02A(H)

DRPT series				
Technical parameter	Relay	Base	Accessory	Assembled module
24DC/1CO/12A	DRPT-1C-LR-D24-02A(H)	DSRT05A-E3-00A(H)	/	DRPTP-1C-D24-02A(H)
220AC/1CO/12A	DRPT-1C-LR-A220-02A(H)	DSRT05A-E3-00A(H)	/	DRPTP-1C-A220-02A(H)
24DC/2CO/8A	DRPT-2C-LR-D24-02A(H)	DSRT08A-E3-00A(H)	/	DRPTP-2C-D24-02A(H)
220AC/2CO/8A	DRPT-2C-LR-A220-02A(H)	DSRT08A-E3-00A(H)	/	DRPTP-2C-A220-02A(H)



+



→



DRPE-2CH-LR-D24-07A(H)

DPYF08A-E3-00A(H)

DRPEP-2CH-D24-07A(H)



+



→



DRPE-2CH-LR-A220-07A(H)

DPYF08A-E3-00A(H)

DRPEP-2CH-A220-07A(H)



+



→



DRPE-4C-LR-D24-07A(H)

DPYF14A-E3-00A(H)

DRPEP-4C-D24-07A(H)



+



→



DRPE-4C-LR-A220-07A(H)

DPYF14A-E3-00A(H)

DRPEP-4C-A220-07A(H)

DRPE series

Technical parameter	Relay	Base	Accessory	Assembled module
24DC/2CO/10A	DRPE-2CH-LR-D24-07A(H)	DPYF08A-E3-00A(H)	/	DRPEP-2CH-D24-07A(H)
220AC/2CO/10A	DRPE-2CH-LR-A220-07A(H)	DPYF08A-E3-00A(H)	/	DRPEP-2CH-A220-07A(H)
24DC/4CO/5A	DRPE-4C-LR-D24-07A(H)	DPYF14A-E3-00A(H)	/	DRPEP-4C-D24-07A(H)
220AC/4CO/5A	DRPE-4C-LR-A220-07A(H)	DPYF14A-E3-00A(H)	/	DRPEP-4C-A220-07A(H)



+



→



DRPL-2C-L-D24-02A(H)

DPTF08A-E3-00A(H)



+



→



DRPL-2C-L-A220-02A(H)

DPTF08A-E3-00A(H)



+



→



DRPL-4C-L-D24-02A(H)

DPTF14A-E3-00A(H)



+



→



DRPL-4C-L-A220-02A(H)

DPTF14A-E3-00A(H)

DRPL series

Technical parameter	Relay	Base	Accessory	Assembled module
24DC/2CO/10A	DRPL-2C-L-D24-02A(H)	DPTF08A-E3-00A(H)	/	/
220AC/2CO/10A	DRPL-2C-L-A220-02A(H)	DPTF08A-E3-00A(H)	/	/
24DC/4CO/10A	DRPL-4C-L-D24-02A(H)	DPTF14A-E3-00A(H)	/	/
220AC/4CO/10A	DRPL-4C-L-A220-02A(H)	DPTF14A-E3-00A(H)	/	/



DRPS

Features

- Small size, 6A switching power.
- Multiple sockets optional.
- Green product RoHS.

Performance Parameters

Contact parameters

Contact form	1C
Contact material	Ag alloy
Resistive load	1C: 6A@250VAC/30VDC
Motor load	1C: 1/3HP@250VAC
Switch power	1C: 4000VA, 480W
Contact resistance (Initial)	<50mΩ
Electrical life (1s on/1s off)	>1x10 ⁵ (1800 Ops/h)
Mechanical life (300cycles/min)	>1x10 ⁷ (18000 Ops/h)

Coil parameters

Rated voltage (DC)	DC12V	DC24V	DC48V	DC60V
Rated resistance (±10%)	847Ω	3388Ω	10618Ω	20570Ω
Operate voltage	DC: ≤75% (Rated voltage)			
Release voltage	DC: ≥10% (Rated voltage)			
Max input voltage	110% (Rated voltage)			
Coil power	0.40W			
Operate time	<8ms			
Release time	<4ms			

Universal parameters

Insulation resistance	1000MΩ(500VDC)
Dielectric voltage	
Between contacts	1000VAC/1min
Between contacts (different pole)	\
Between contacts and coil	4000VAC/1min
Shock withstanding	10G (Half sine wave pulse 11ms)
Vibration withstanding	10-55Hz (Double amplitude 1.0mm)
Ambient temperature	-40...+55°C
Ambient humidity	35%~80%RH
Weight	17g
Matching socket	1C: DPSF06A series

DRPS - 1C - D24 - 06A (H)

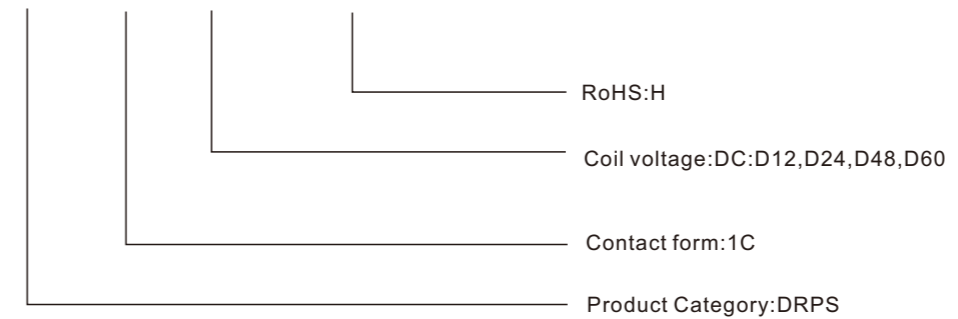

Overall Dimensions

DRPS-1C

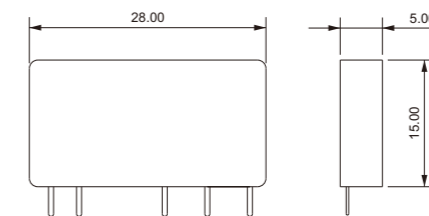

Installation Diagrams, Wiring Diagrams

DRPS-1C

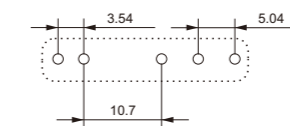

DRPS-1C

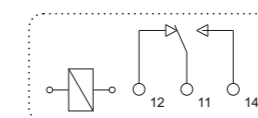



DPSF

Features

- Protective socket,6A.
- Green product RoHS.

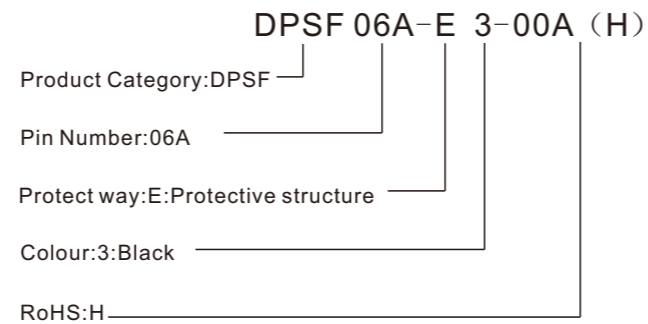

DPSF series black socket will be stopped in 2023 Q3, we will publish official PDN

Performance Parameters

Technical parameters

Product type	DPSF06A-E3
Rated current	6A
Rated voltage	250V
Coil/Contact dielectric voltage	4000V/S
Dielectric voltage between contact	2500V/S
Screw torque	0.5Nm
External connection wire	20-16AWG/0.5-1.5mm ²
Ambient temperature	-40~+70°C
Weight	22g

Supporting relays and accessories

Product type	Relay	Short splice
DPSF06A-E3	DRPS	DBA20-6-12-00A(H) Color: blue
		DBA20-6-13-00A(H) Color: black
		DBA20-6-16-00A(H) Color: red

Overall Dimensions, Wiring Diagrams

DPSF06A-E3

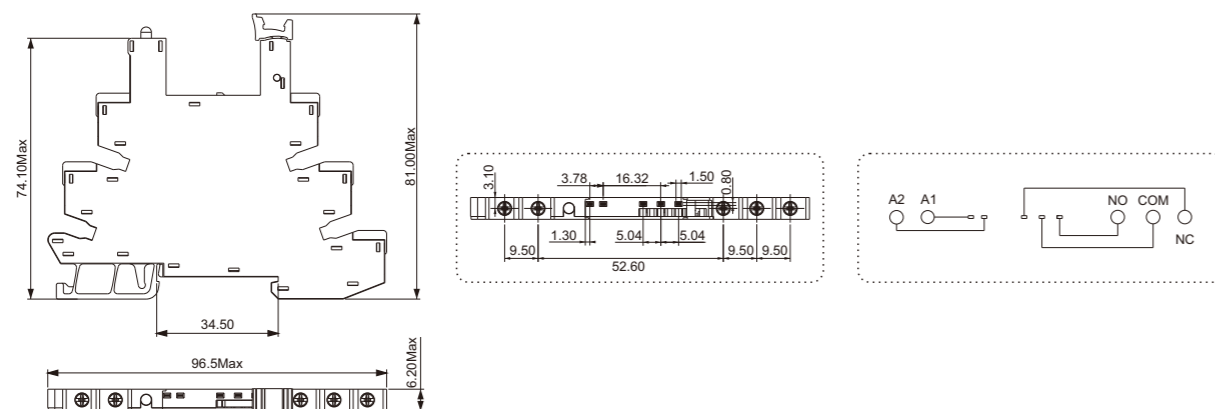

DPSF

Features

- Protective socket,6A.
- Green product RoHS.

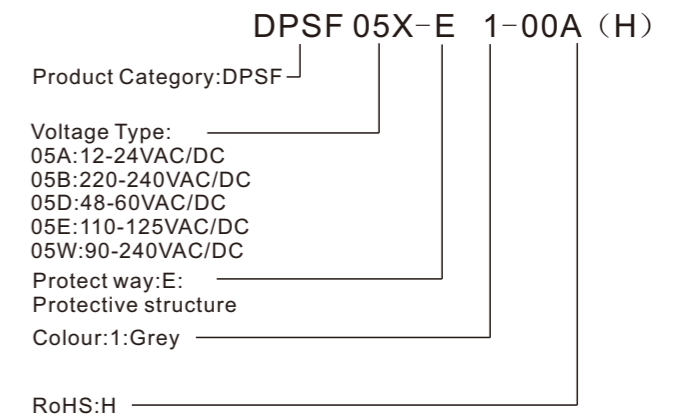

Performance Parameters

Technical parameters

Product type	DPSF05X-E1
Rated current	6A
Rated voltage	250V
Coil/Contact dielectric voltage	4000V/S
Dielectric voltage between contact	2500V/S
Screw torque	0.5Nm
External connection wire	20-16AWG/0.5-1.5mm ²
Ambient temperature	-40~+70°C
Weight	26g

Supporting relays and accessories

Product type	Relay	Short splice
DPSF05A-E1	DRPS-1C-D12/D24	DBA20-6-12-00A(H) Color: blue
DPSF05B-E1/DPSF05E-E1	DRPS-1C-D60	DBA20-6-13-00A(H) Color: black
DPSF05D-E1	DRPS-1C-D48/D60	DBA20-6-16-00A(H) Color: red
DPSF05W-E1	DRPS-1C-D24	

Overall Dimensions, Wiring Diagrams

DPSF05X-E1

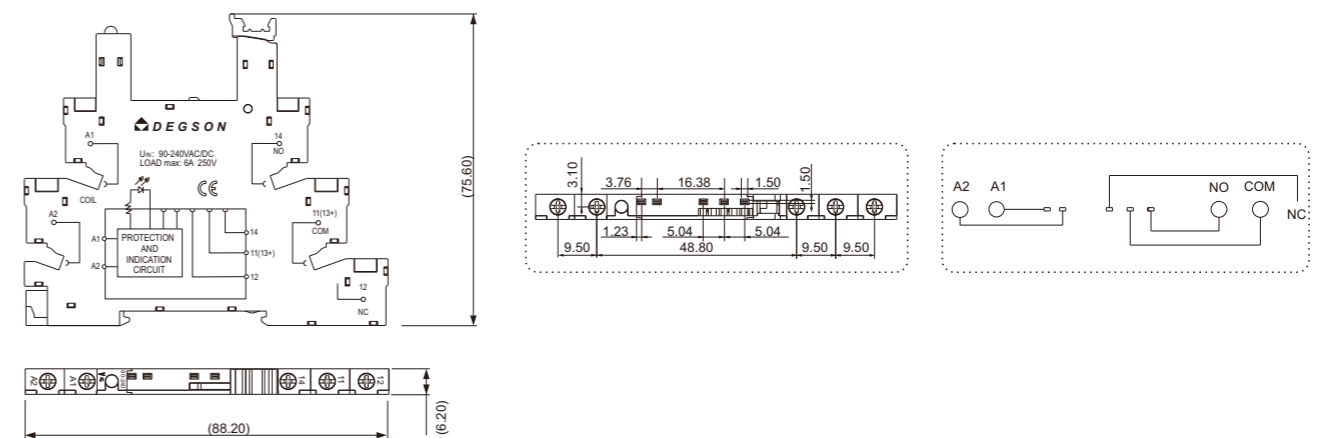

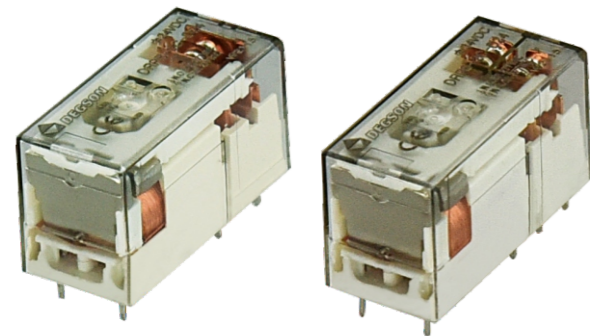

DRPB-1C

DRPB-1CH/DRPB-2C

Features

- Small size, 1C:12A, 1CH:16A, 2C:8A switching power.
- Multiple sockets optional.
- Green product RoHS.

Performance Parameters

Contact parameters

Contact form	1C, 1CH, 2C
Contact material	Ag alloy
Resistive load	1C: 16A 1CH: 16A@277VAC/30VDC 2C: 8A@277VAC/30VDC
Motor load	1CH: 1/3HP@240VAC 2C: 1/6HP@240VAC
Switch power	1CH: 4000VA, 480W 2C: 2000VA, 240W
Contact resistance (Initial)	<50mΩ
Electrical life (1s on/1s off)	>1x10 ⁵ (1800 Ops/h)
Mechanical life (300cycles/min)	>1x10 ⁷ (18000 Ops/h)

Coil parameters

Rated voltage (DC)	DC6V	DC12V	DC24V	DC48V
Rated resistance (±10%)	90Ω	360Ω	1440Ω	5760Ω
Operate voltage	DC: ≤75% (Rated voltage)			
Release voltage	DC: ≥5% (Rated voltage)			
Max input voltage	110% (Rated voltage)			
Coil power	0.40W			
Operate time	<20ms			
Release time	<10ms			

Universal parameters

Insulation resistance	1000MΩ(500VDC)
Dielectric voltage	
Between contacts	1000VAC/1min
Between contacts (different pole)	3000VAC/1min
Between contacts and coil	5000VAC/1min
Shock withstanding	10G (Half sine wave pulse 11ms)
Vibration withstanding	10-55Hz (Double amplitude 1.0mm)
Ambient temperature	-25...+70°C
Ambient humidity	35%~80%RH
Weight	17g
Matching socket	1C: DSRC05A series ; 1CH/2C: DSRC08A series

DRPB - 2C - D24 - 06A (H)

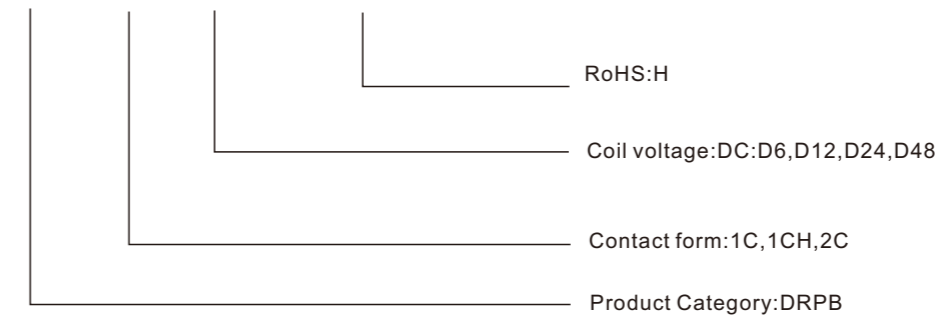

Overall Dimensions

DRPB-1C

DRPB-1CH/2C

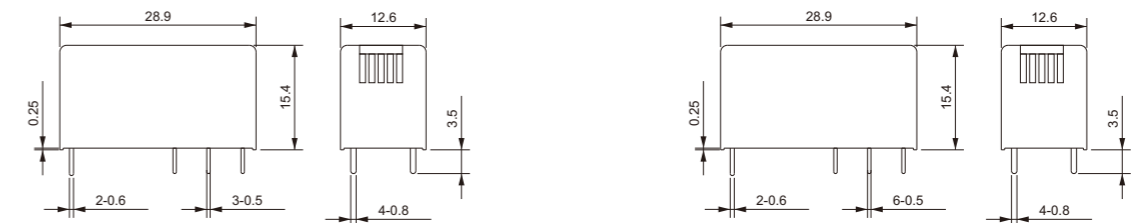

Installation Diagrams, Wiring Diagrams

DRPB-1C

DRPB-1CH

DRPB-2C

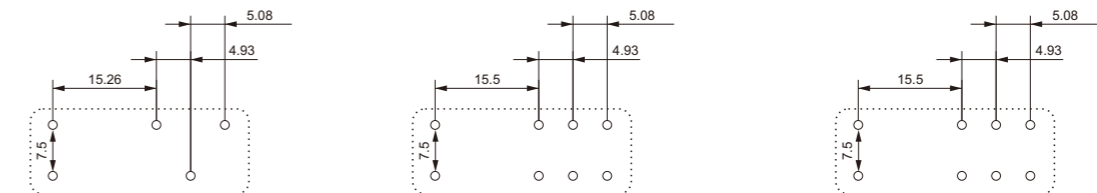

DRPB-1C

DRPB-1CH

DRPB-2C

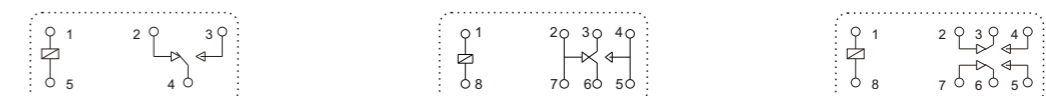



DSRC05A-F3

DSRC08A-F3

Features

- Separable socket,05A:10A,08A:7A.
- Green product RoHS.

Product Category:DSRC
 Pin Number:05A,08A
 Protect way:F:Separable structure
 Colour:3:Black
 RoHS:H

DSRC 08A-F 3-00A (H)

Performance Parameters

Technical parameters

Product type	DSRC05A-F3	DSRC08A-F3
Rated current	12A	10A
Rated voltage	300V	
Coil/Contact dielectric voltage	2500V/S	
Dielectric voltage between contact	2500V/S	
Screw torque	1.0Nm	
External connection wire	20-14AWG/0.5-2.5mm ²	
Ambient temperature	-40~+65°C	
Weight	22g	27g

Supporting relays and accessories

Product type	Relay	Module	Plastic pull clasp	Metal clamp spring
DSRC05A-F3	DRPB-1C	DMD	Wear	—
DSRC08A-F3	DRPB-1CH/DRPB-2C	DMD	Wear	—

Overall Dimensions, Wiring Diagrams

DSRC05A-F3

DSRC08A-F3

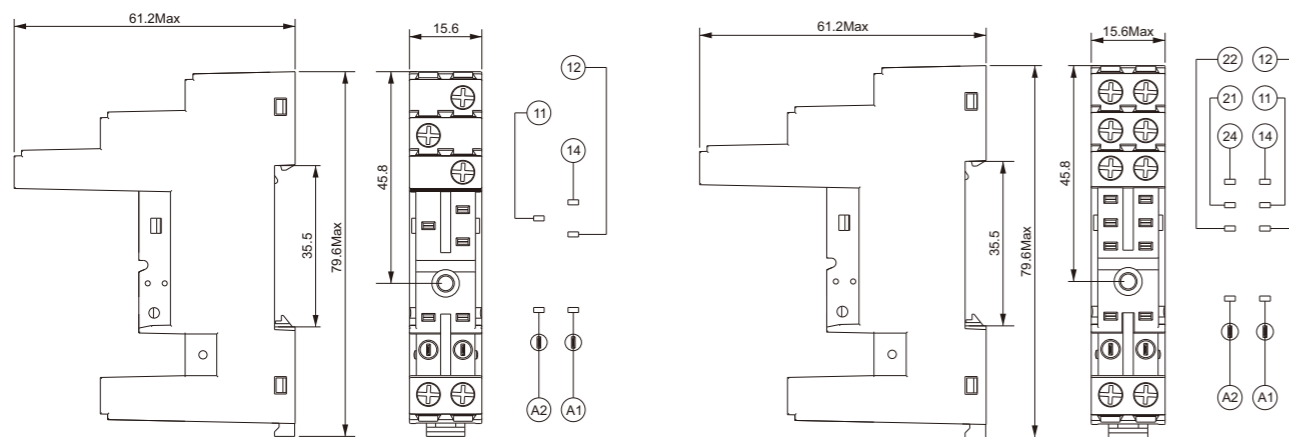

DMD

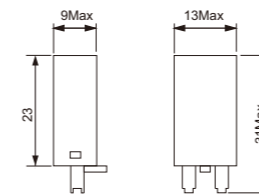

Features

- Peak voltage inhibit,over voltage protection,voltage indicator.
- Green product RoHS.

Product Category:DMD,DND
 Function option:
 L:LED;ML:Varistor+LED
 LD:LED+diode;M:Varistor
 RC:Resistance capacity;D:diode
 Direction of current:Blank:A1-;1:A1+
 Voltage:See table corresponding
 RoHS:H

DMD-ML 1-D24-00A (H)

Function	L	D	LD	ML	M	RC	L1	D1	LD1	ML1
Wiring diagrams										
Voltage option	6-24V 110-240V	6-250VDC	6-24VDC 110/240VDC	24V 120V 240V	24V	6-24VDC 110/240VDC	6-24V 110-240V	6-250VDC	6-24VDC 110/240VDC	24V 120V 240V



DRPT-1C



DRPT-2C

Features

- Small size, 1C:12A,2C:8A switching power.
- Multiple sockets optional.
- With test button ,diode and LED.
- Green product RoHS .

Performance Parameters

Contact parameters

Contact form	1C,2C	
Contact material	Ag alloy	
Resistive load	1C:12A@277VAC/30VDC	2C:8A@277VAC/30VDC
Motor load	1C:1/2HP@250VAC	2C:1/3HP@250VAC
Switch power	1C:3324VA/360W	2C:2216VA/240W
Contact resistance(Initial)	≤100mΩ	
Electrical life(1s on/1s off)	>1x10 ⁵ (1800 Ops/h)	
Mechanical life(300cycles/min)	>1x10 ⁷ (18000 Ops/h)	

Coil parameters

Rated voltage (DC)	DC6V	DC12V	DC24V	DC48V	DC110V	
Rated resistance(±10%)	68Ω	272Ω	1087Ω	4347Ω	22830Ω	
Rated voltage (AC)	AC6V	AC12V	AC24V	AC48V	AC100-110V	AC220-240V
Rated resistance(±10%)	15.8Ω	63Ω	252Ω	1008Ω	5294Ω	23144Ω
Operate voltage	DC:≤75%(Rated voltage);AC:≤80%(Rated voltage)					
Release voltage	DC:≥10%(Rated voltage);AC:≥30%(Rated voltage)					
Max input voltage	110%(Rated voltage)					
Coil power	0.53W/0.8-1.0VA					
Operate time	<20ms					
Release time	<10ms					

Universal parameters

Insulation resistance	1000MΩ(500VDC/min)
Dielectric voltage	
Between contacts	1000VAC/1min
Between contacts(different pole)	1000VAC/1min
Between contacts and coil	5000VAC/1min
Shock withstanding	10G(Half sine wave pulse 11ms)
Vibration withstanding	10-55Hz(Double amplitude 1.0mm)
Ambient temperature	-40...+85°C
Ambient humidity	45%~75%RH
Weight	25g
Matching socket	1C:DSRT05A series ; 2C:DSRT08A series

DRPT - 2C - LR - D24 - 02A (H)

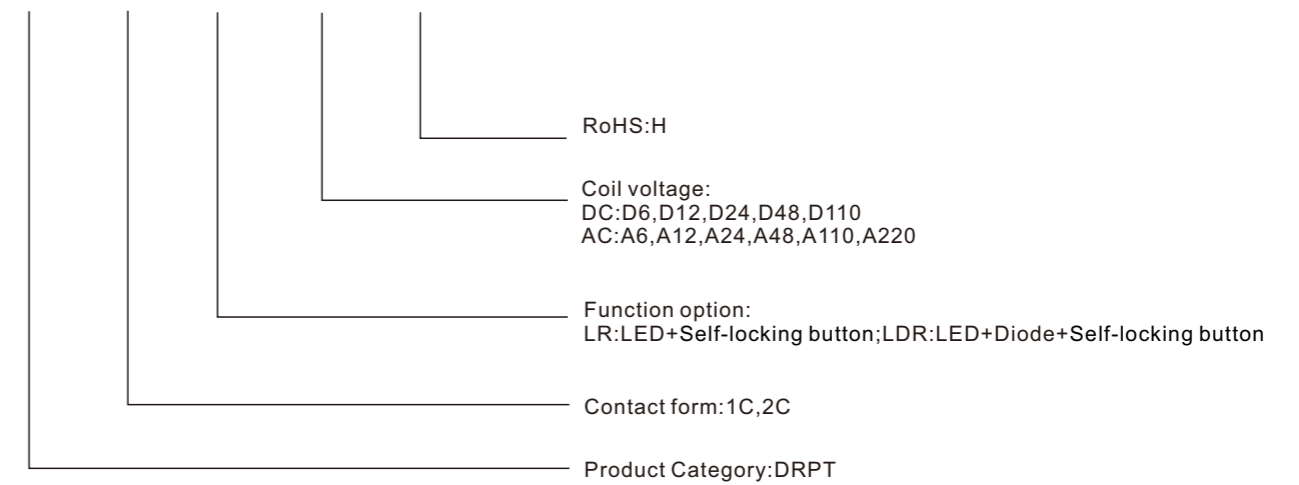

Overall Dimensions

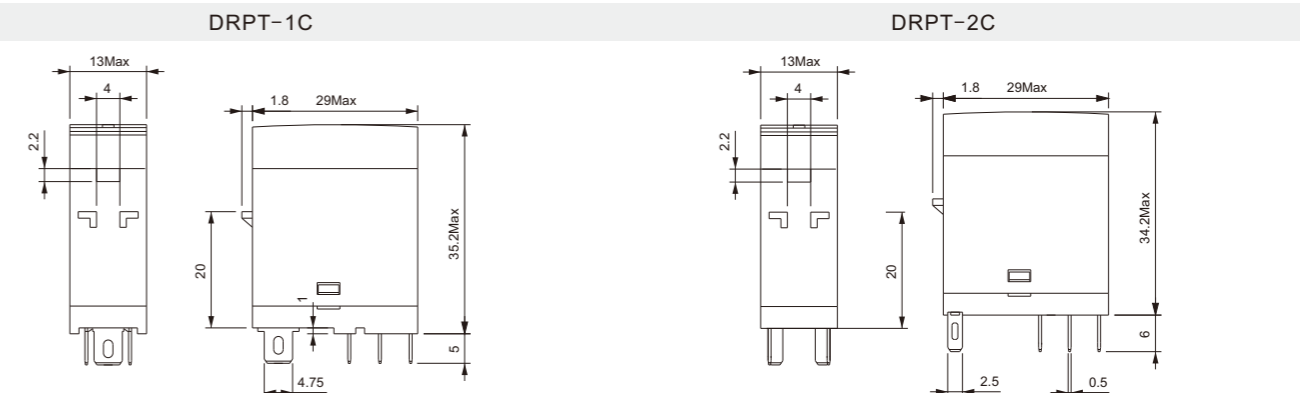

Installation Diagrams, Wiring Diagrams

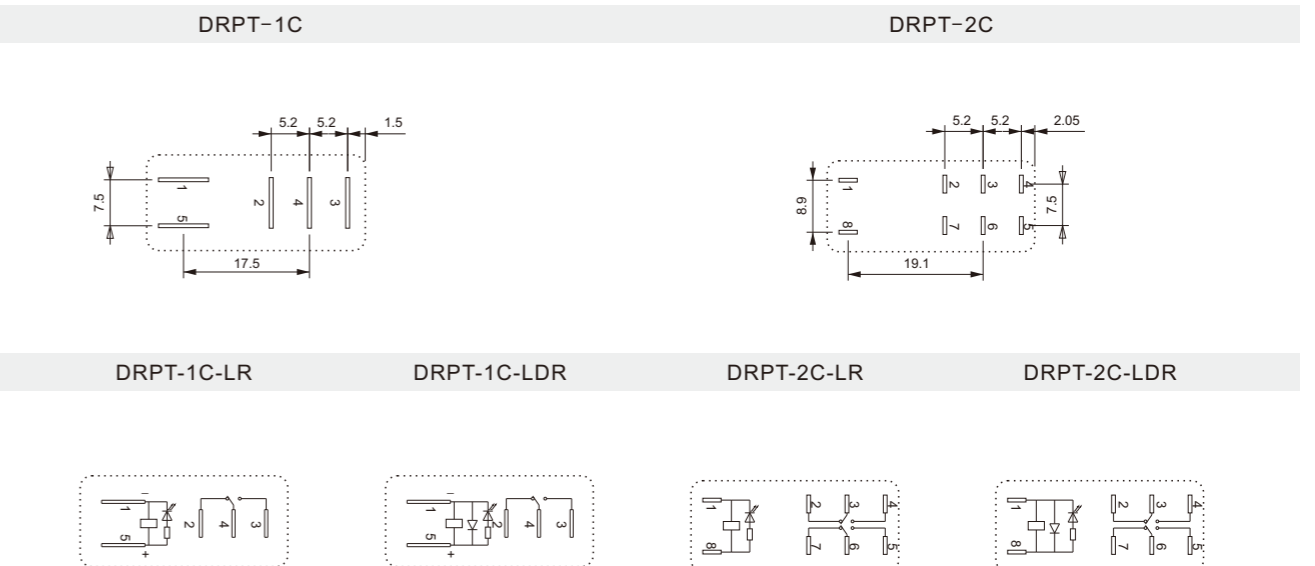

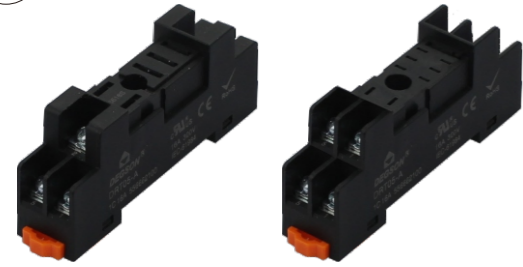

DSRT05A-3

DSRT08A-3

Features

- Protective socket,05A:16A,08A:10A.
- Green product RoHS.

DSRT 08A-3-00A (H)

Product Category:DSRT

Pin Number:05A,08A

Colour:3:Black

RoHS:H

Performance Parameters

Technical parameters

Product type	DSRT05A-3	DSRT08A-3
Rated current	16A	10A
Rated voltage	300V	
Coil/Contact dielectric voltage	4000V/S	
Dielectric voltage between contact	2500V/S	
Screw torque	1.0Nm	
External connection wire	20-14AWG/0.5-2.5mm ²	
Ambient temperature	-45~+85°C	
Weight	22g	27g

Supporting relays and accessories

Product type	Relay	Module	Plastic pull clasp	Metal clamp spring
DSRT05A-3	DRPT-1C	—	Wear	—
DSRT08A-3	DRPT-2C	—	Wear	—

Overall Dimensions, Wiring Diagrams

DSRT05A-3

DSRT08A-3

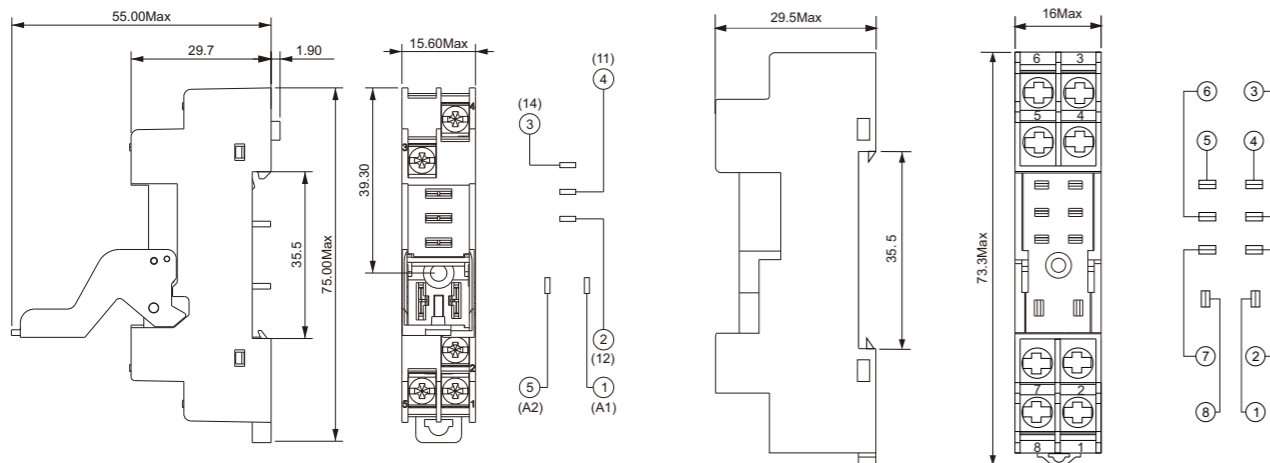

DSRT05A-E3

DSRT08A-E3

Features

- Protective socket,05A:16A,08A:10A.
- Green product RoHS.

DSRT 08A-E 3-00A (H)

Product Category:DSRT

Pin Number:05A,08A

Protect way:E:Protective structure

Colour:3:Black

RoHS:H

Performance Parameters

Technical parameters

Product type	DSRT05A-E3	DSRT08A-E3
Rated current	16A	10A
Rated voltage	300V	
Coil/Contact dielectric voltage	2000V/S	
Dielectric voltage between contact	2000V/S	
Screw torque	1.0Nm	
External connection wire	20-14AWG/0.5-2.5mm ²	
Ambient temperature	-40~+65°C	
Weight	22g	27g

Supporting relays and accessories

Product type	Relay	Module	Plastic pull clasp	Metal clamp spring
DSRT05A-E3	DRPT-1C	—	Wear	—
DSRT08A-E3	DRPT-2C	—	Wear	—

Overall Dimensions, Wiring Diagrams

DSRT05A-E3

DSRT08A-E3

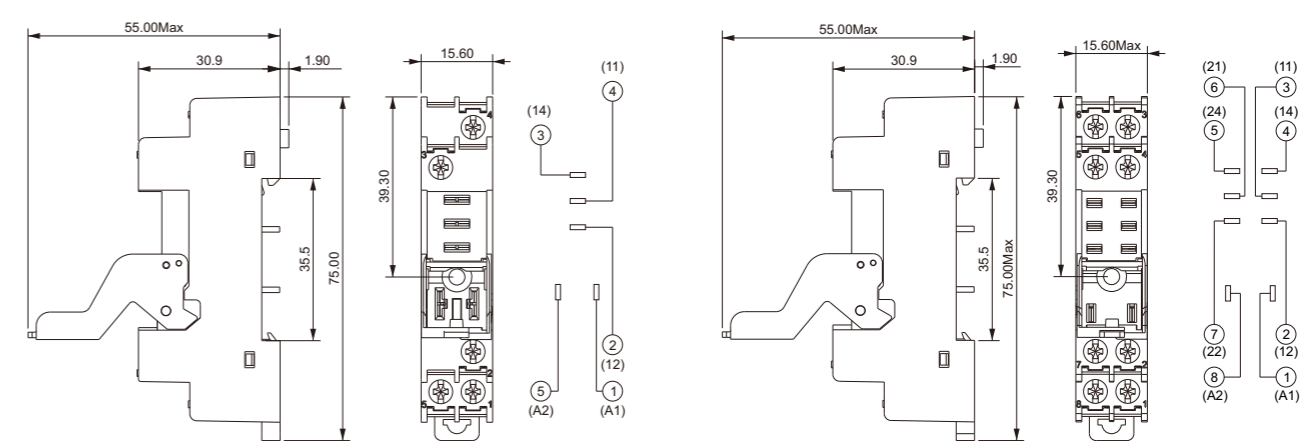



DSRT05A-F3

DSRT08A-F3

Features

- General socket,05A:16A,08A:10A.
- Green product RoHS.

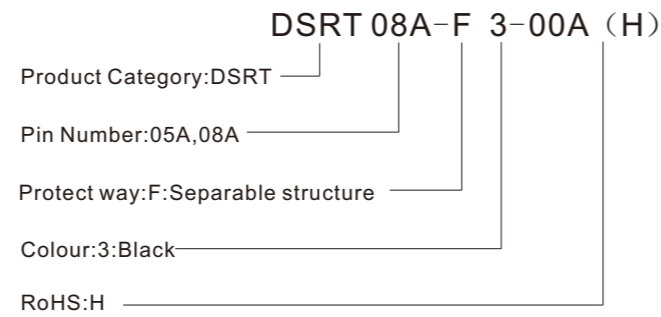

Performance Parameters

Technical parameters

Product type	DSRT05A-F3	DSRT08A-F3
Rated current	16A	10A
Rated voltage	300V	
Coil/Contact dielectric voltage	4000V/S	
Dielectric voltage between contact	2500V/S	
Screw torque	1.0Nm	
External connection wire	20-14AWG/0.5-2.5mm ²	
Ambient temperature	-45~+85°C	
Weight	22g	27g

Supporting relays and accessories

Product type	Relay	Module	Plastic pull clasp	Metal clamp spring
DSRT05A-F3	DRPT-1C	DMD	Wear	—
DSRT08A-F3	DRPT-2C	DMD	Wear	—

Overall Dimensions, Wiring Diagrams

DSRT05A-F3

DSRT08A-F3

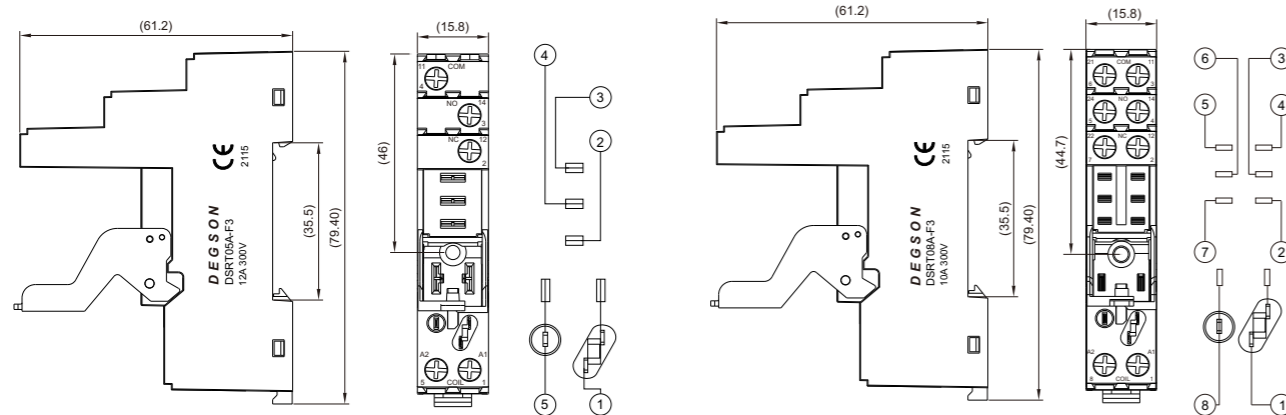

DPRT05A-F3

DPRT08A-F3

Features

- Push-in connection, general socket,05A:16A,08A:10A.
- Green product RoHS.

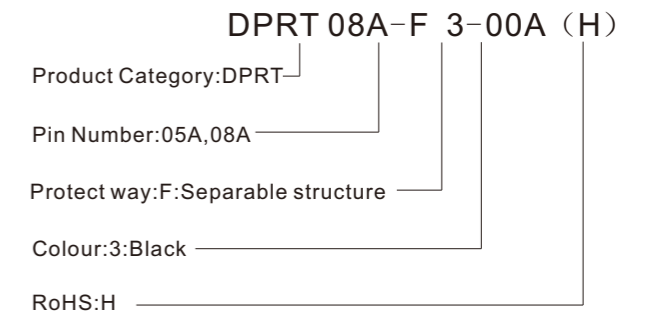

Performance Parameters

Technical parameters

Product type	DPRT05A-F3	DPRT08A-F3
Rated current	16A	10A
Rated voltage	300V	
Coil/Contact dielectric voltage	4000V/S	
Dielectric voltage between contact	2500V/S	
Screw torque	20-14AWG/0.5-2.5mm ²	
External connection wire	-45~+85°C	
Ambient temperature	32g	42g
Weight		

Supporting relays and accessories

Product type	Relay	Module	Plastic pull clasp	Metal clamp spring
DPRT05A-F3	DRPT-1C	DMD	Wear	—
DPRT08A-F3	DRPT-2C	DMD	Wear	—

Overall Dimensions, Wiring Diagrams

DPRT05A-F3

DPRT08A-F3

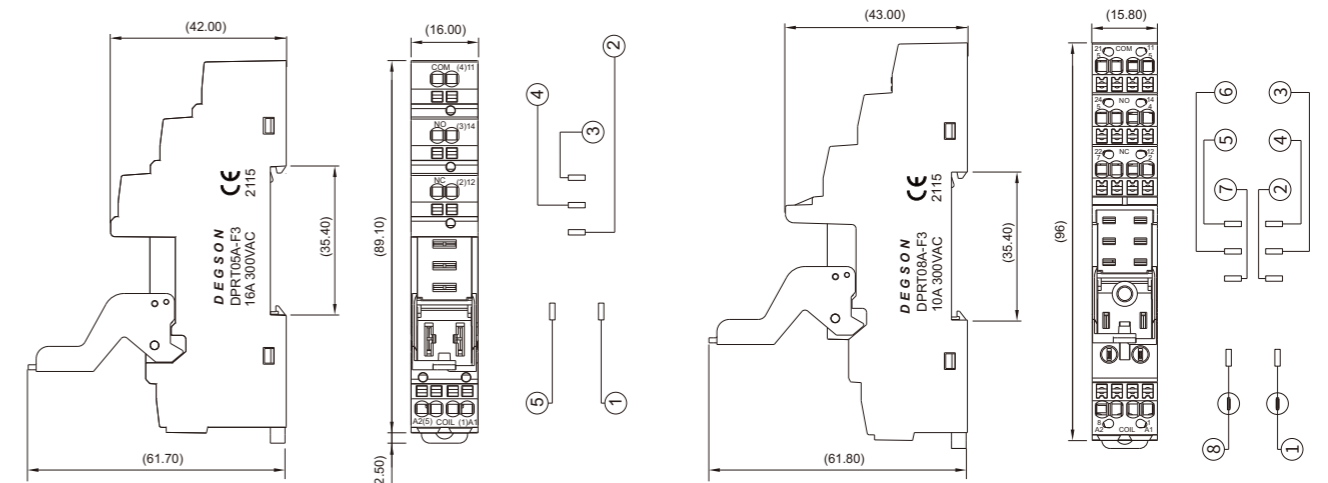



DRPE-2CH



DRPE-4C

Features

- Small size, 2CH:10A, 4C:5A switching power.
- Multiple sockets optional.
- With test button and instruction window.
- Green product **RoHS**.

Performance Parameters
Contact parameters

Contact form	2CH, 4C	
Contact material	Ag alloy	
Resistive load	2CH:10A@240VAC/28VDC	4C:5A@240VAC/28VDC
Switch power	2CH:2400VA/280W	4C:1200VA/140W
Contact resistance(Initial)	<50mΩ	
Electrical life(1s on/1s off)	>1x10 ⁵ (1800 Ops/h)	
Mechanical life(300cycles/min)	>1x10 ⁷ (18000 Ops/h)	

Coil parameters

Rated voltage (DC)	DC12V	DC24V	DC48V	DC110V	DC220V
Rated resistance(±10%)	160Ω	640Ω	2560Ω	13000Ω	53777Ω
Rated voltage (AC)	AC24V	AC48V	AC110V	AC220V	AC380V
Rated resistance(±10%)	168Ω	672Ω	3529Ω	14116Ω	42116Ω
Operate voltage	DC:≤75%(Rated voltage); AC:≤80%(Rated voltage)				
Release voltage	DC:≥10%(Rated voltage); AC:≥30%(Rated voltage)				
Max input voltage	110%(Rated voltage)				
Coil power	0.9W/1.2VA				
Operate time	<20ms				
Release time	<20ms				

Universal parameters

Insulation resistance	1000MΩ(500VDC)
Dielectric voltage	
Between contacts	1000VAC/1min
Between contacts(different pole)	1500VAC/1min
Between contacts and coil	1500VAC/1min
Shock withstanding	10G(Half sine wave pulse 11ms)
Vibration withstanding	10-55Hz(Double amplitude 1.0mm)
Ambient temperature	-25...+55°C
Ambient humidity	45%~75%RH
Weight	35g
Matching socket	2CH:DPYF08A series DPKF08A series ; 4C:DPYF14A series DPKF14A series

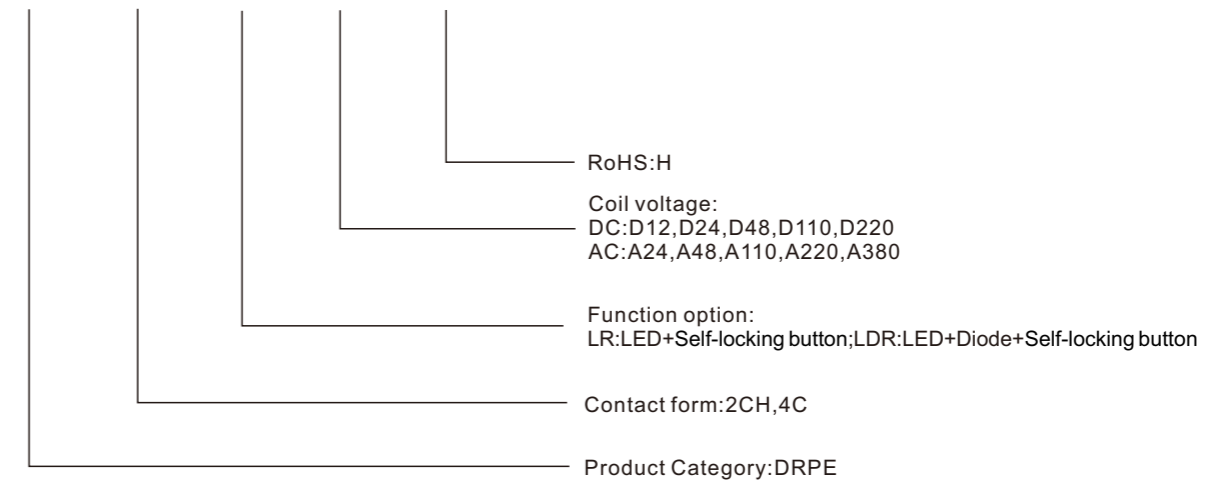
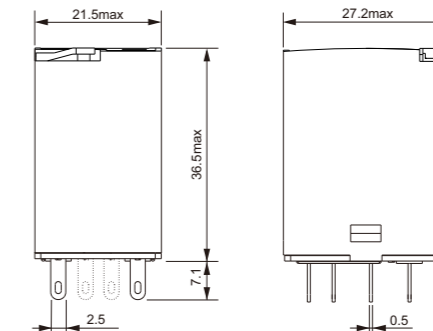
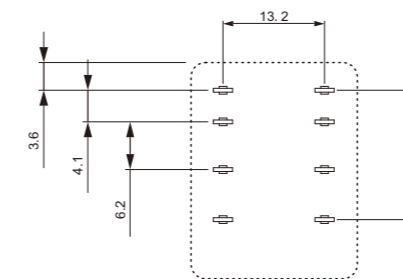
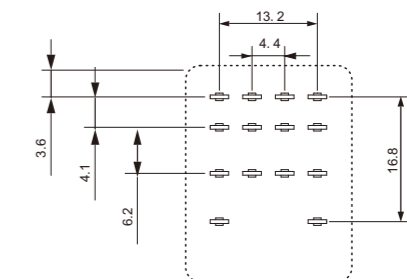
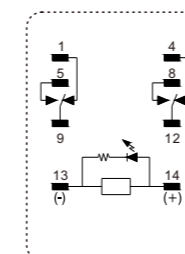
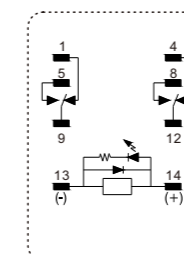
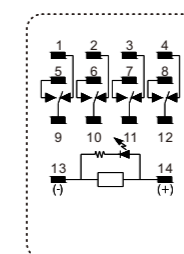
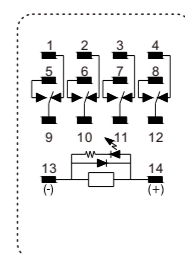
DRPE - 2CH -LR - D24 - 07A (H)

Overall Dimensions
DRPE-2CH/4C

Installation Diagrams, Wiring Diagrams
DRPE-2CH

DRPE-4C

DRPE-2CH-LR

DRPE-2CH-LDR

DRPE-4C-LR

DRPF-4C-LDR



DPYF08A-3

DPYF14A-3

Features

- General socket,08A:10A, 14A:7A.
- Green product RoHS.

DPYF 08A-3-00A (H)

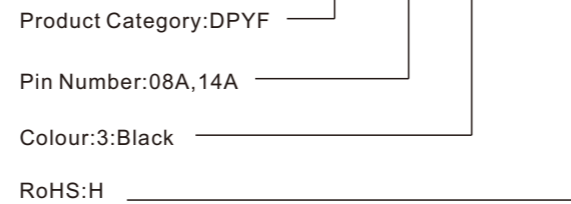

Performance Parameters

Technical parameters

Product type	DPYF08A-3	DPYF14A-3
Rated current	10A	7A
Rated voltage	300V	
Coil/Contact dielectric voltage	2000V/S	
Dielectric voltage between contact	2000V/S	
Screw torque	1.0Nm	
External connection wire	20-14AWG/0.5-2.5mm ²	
Ambient temperature	-40~+65°C	
Weight	34g	56g

Supporting relays and accessories

Product type	Relay	Module	Plastic pull clasp	Metal clamp spring
DPYF08A-3	DRPE-2CH	—	—	Wear
DPYF14A-3	DRPE-4C	—	—	Wear

Overall Dimensions, Wiring Diagrams

DPYF08A-3

DPYF14A-3

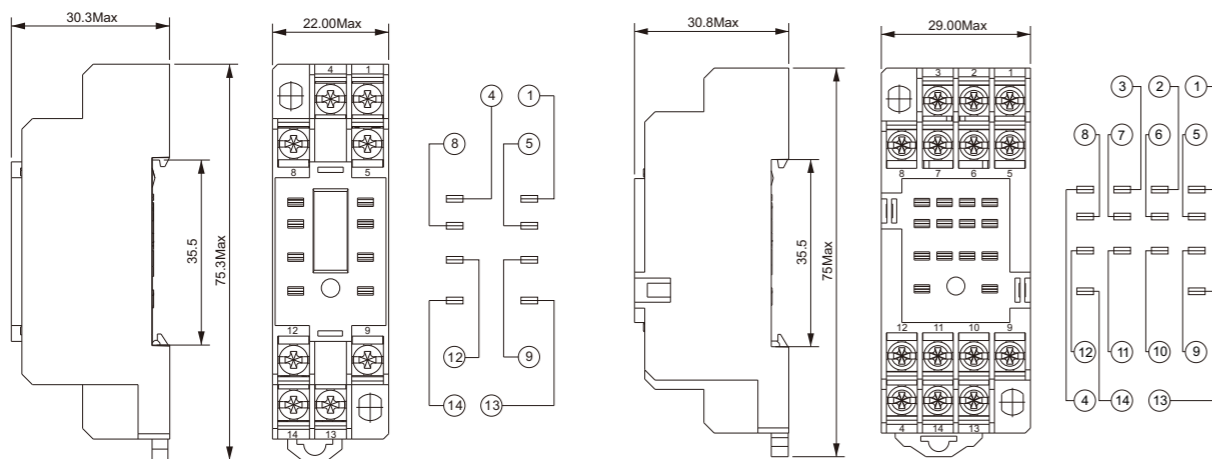

DPYF08A-E3

DPYF14A-E3

Features

- Protective socket,08A:10A,14A:7A.
- Green product RoHS.

DPYF 08A-E 3-00A (H)

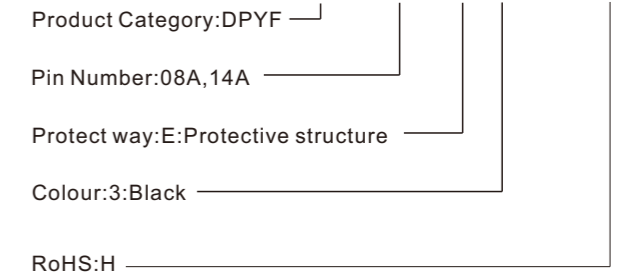

Performance Parameters

Technical parameters

Product type	DPYF08A-E3	DPYF14A-E3
Rated current	10A	7A
Rated voltage	300V	
Coil/Contact dielectric voltage	2000V/S	
Dielectric voltage between contact	2000V/S	
Screw torque	1.0Nm	
External connection wire	20-14AWG/0.5-2.5mm ²	
Ambient temperature	-40~+65°C	
Weight	34g	56g

Supporting relays and accessories

Product type	Relay	Module	Plastic pull clasp	Metal clamp spring
DPYF08A-E3	DRPE-2CH	—	—	Wear
DPYF14A-E3	DRPE-4C	—	—	Wear

Overall Dimensions, Wiring Diagrams

DPYF08A-E3

DPYF14A-E3

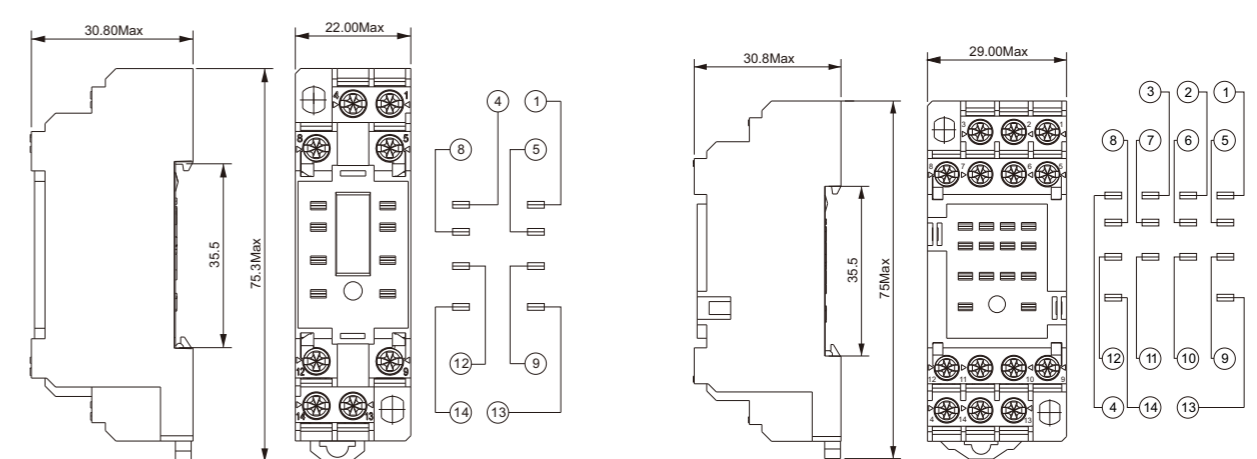

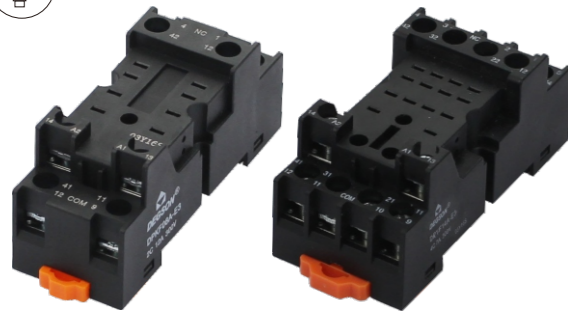

DPKF08A-E3

DPKF14A-E3

Features

- Protective socket,08A:12A,14A:10A.
- Green product RoHS.

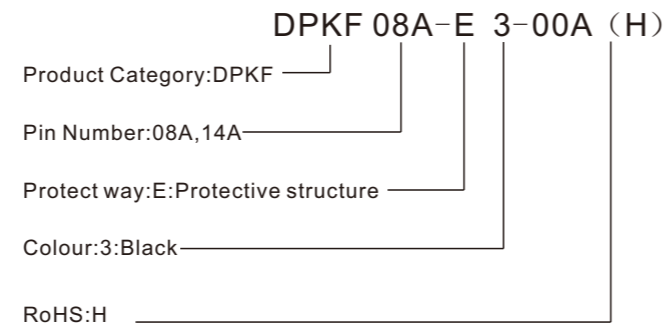

Performance Parameters

Technical parameters

Product type	DPKF08A-E3	DPKF14A-E3
Rated current	12A	10A
Rated voltage	300V	
Coil/Contact dielectric voltage	2500V/S	
Dielectric voltage between contact	2500V/S	
Screw torque	1.0Nm	
External connection wire	20-14AWG/0.5-2.5mm ²	
Ambient temperature	-40~+85°C	
Weight	35g	45g

Supporting relays and accessories

Product type	Relay	Module	Plastic pull clasp	Metal clamp spring
DPKF08A-E3	DRPE-2CH	—	—	T-35A
DPKF14A-E3	DRPE-4C	DMD	—	T-35A

Overall Dimensions, Wiring Diagrams

DPKF08A-E3

DPKF14A-E3

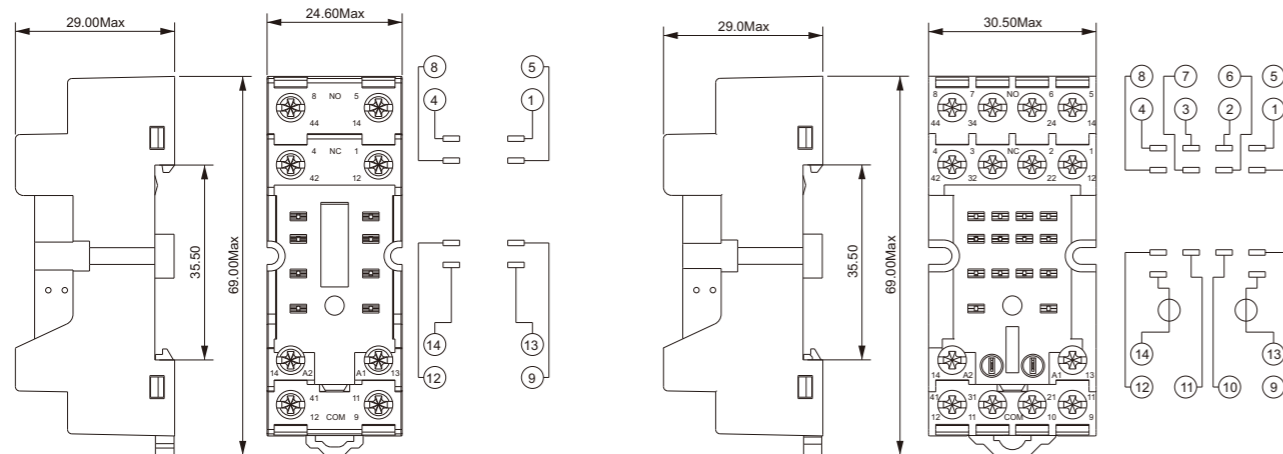

DPKF08A-F3

DPKF14A-F3

Features

- Separable structure socket,08A:12A,14A:10A.
- Green product RoHS.

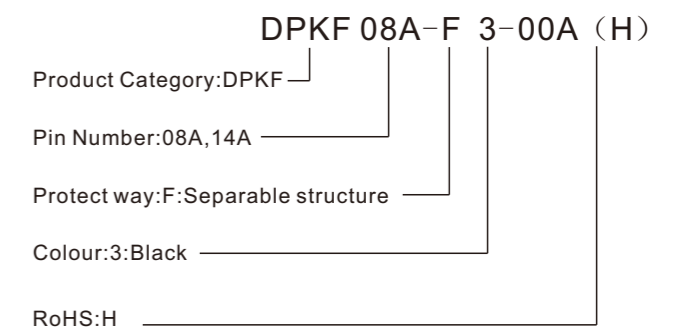

Performance Parameters

Technical parameters

Product type	DPKF08A-F3	DPKF14A-F3
Rated current	12A	10A
Rated voltage	300V	
Coil/Contact dielectric voltage	4000V/S	
Dielectric voltage between contact	2500V/S	
Screw torque	1.0Nm	
External connection wire	20-14AWG/0.5-2.5mm ²	
Ambient temperature	-40~+85°C	
Weight	50g	62g

Supporting relays and accessories

Product type	Relay	Module	Plastic pull clasp	Metal clamp spring
DPKF08A-F3	DRPE-2CH	DMD	Wear	—
DPKF14A-F3	DRPE-4C	DMD	Wear	—

Overall Dimensions, Wiring Diagrams

DPKF08A-F3

DPKF14A-F3

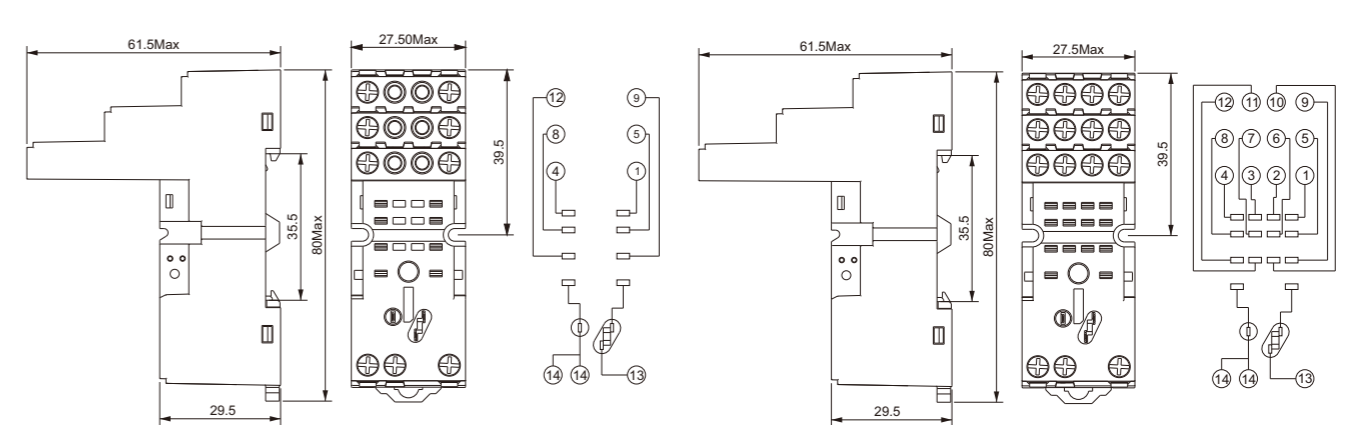



DRPL-2C



DRPL-4C

Features

- High power, 10A switching power.
- Multiple sockets optional.
- Various specification, LED is optional.
- Green product RoHS.

Performance Parameters
Contact parameters

Contact form	2C, 4C
Contact material	AgNi, AgSnO
Resistive load	10A@250VAC/28VDC
Motor load	2C: 1/3HP@240VAC 4C: 1/6HP@240VAC
Switch power	2500VA, 300W
Contact resistance (Initial)	<50mΩ
Electrical life (1s on/1s off)	>1x10 ⁵ (1800 Ops/h)
Mechanical life (300cycles/min)	>1x10 ⁷ (18000 Ops/h)

Coil parameters

	DC12V	DC24V	DC48V	DC110V	DC220V
Rated voltage (DC)	DC12V	DC24V	DC48V	DC110V	DC220V
Rated resistance (±10%)	2C: 180Ω	640Ω	2600Ω	13000Ω	42000Ω
	4C: 96Ω	360Ω	1540Ω	6800Ω	29000Ω
Rated voltage (AC)	AC24V	AC48V	AC110V	AC230V	AC380V
Rated resistance (±10%)	2C: 180Ω	640Ω	4430Ω	16500Ω	42000Ω
	4C: 80Ω	320Ω	1680Ω	8000Ω	20000Ω
Operate voltage	DC: ≤75% (Rated voltage); AC: ≤80% (Rated voltage)				
Release voltage	DC: ≥10% (Rated voltage); AC: ≥30% (Rated voltage)				
Max input voltage	110% (Rated voltage)				
Coil power	2C: 0.9W/1.2VA ; 4C: 1.5W/2.5VA				
Operate time	<20ms				
Release time	<20ms				

Universal parameters

Insulation resistance	500MΩ(500VDC)
Dielectric voltage	
Between contacts	1000VAC/1min
Between contacts (different pole)	2000VAC/1min
Between contacts and coil	2000VAC/1min
Shock withstanding	10G (Half sine wave pulse 11ms)
Vibration withstanding	10-55Hz (Double amplitude 1.0mm)
Ambient temperature	-40...+70°C
Ambient humidity	35%~85%RH
Weight	35g
Matching socket	2C: DPTF08A series ; 4C: DPTF14A series

DRPL-4C-L-D24-02A(H)

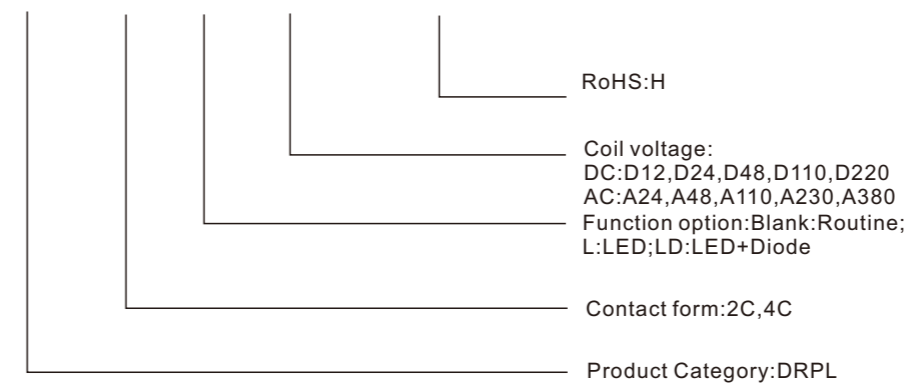
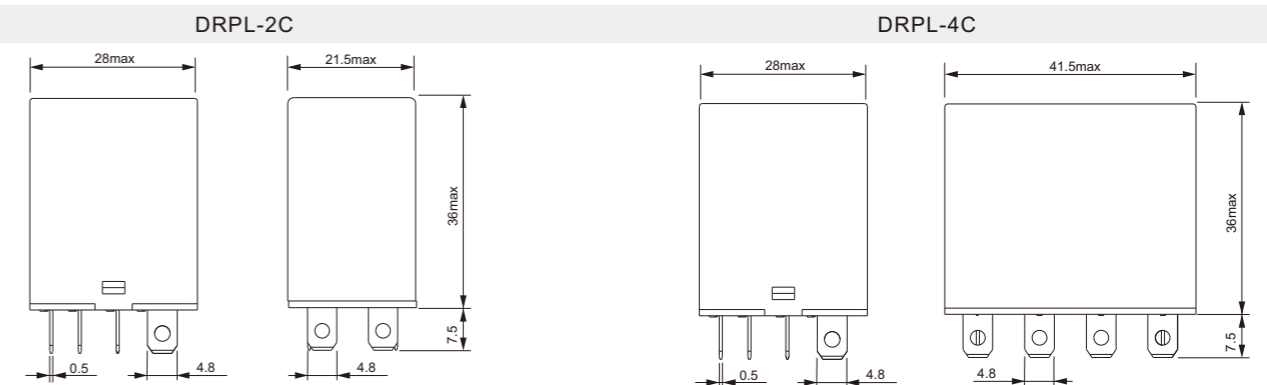
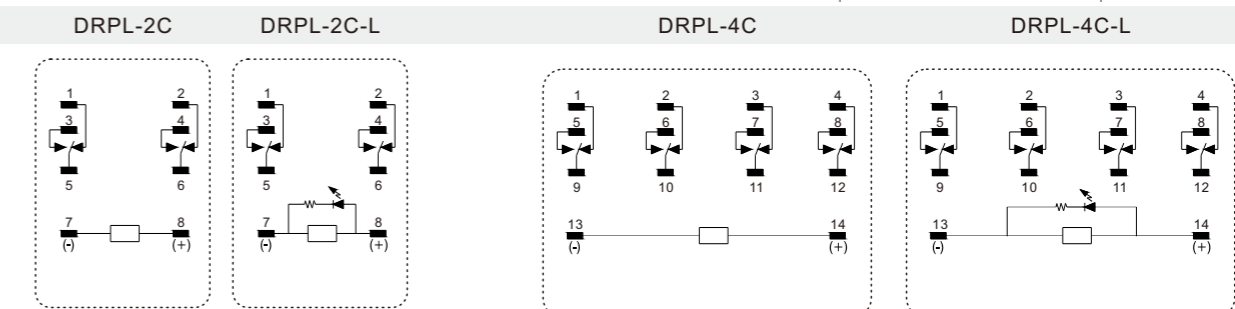
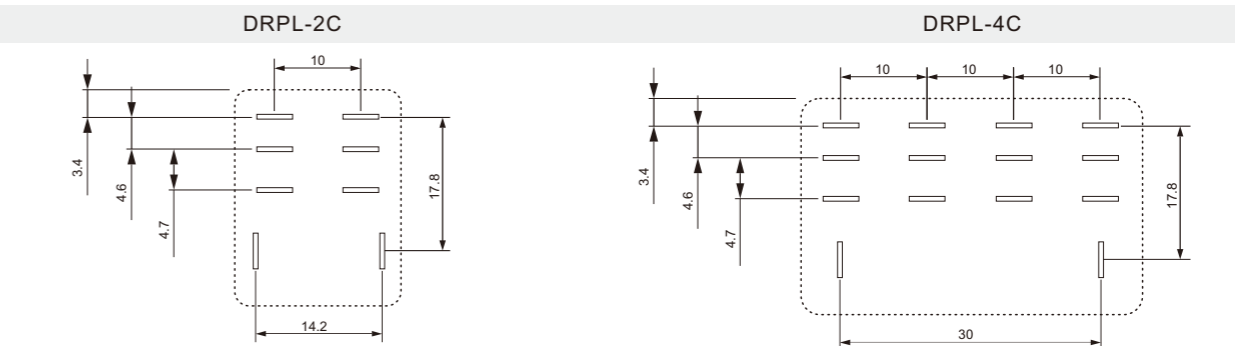
Overall Dimensions

Installation Diagrams, Wiring Diagrams



DPTF08A-3

DPTF14A-3

Features

- General socket, 10A.
- Green product RoHS.

DPTF 08A-3-00A (H)

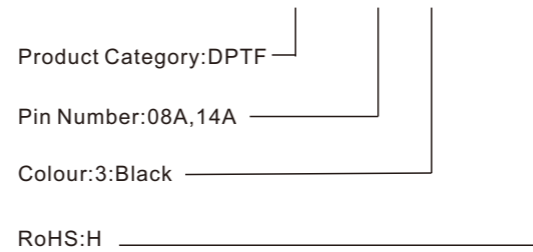

Performance Parameters

Technical parameters

Product type	DPTF08A-3	DPTF14A-3
Rated current	10A	10A
Rated voltage	300V	
Coil/Contact dielectric voltage	2000V/S	
Dielectric voltage between contact	2000V/S	
Screw torque	1.2Nm	
External connection wire	20-14AWG/0.5-2.5mm ²	
Ambient temperature	-40~+65°C	
Weight	45g	76g

Supporting relays and accessories

Product type	Relay	Module	Plastic pull clasp	Metal clamp spring
DPTF08A-3	DRPL-2C	—	—	Wear
DPTF14A-3	DRPL-4C	—	—	Wear

Overall Dimensions, Wiring Diagrams

DPTF08A-3

DPTF14A-3

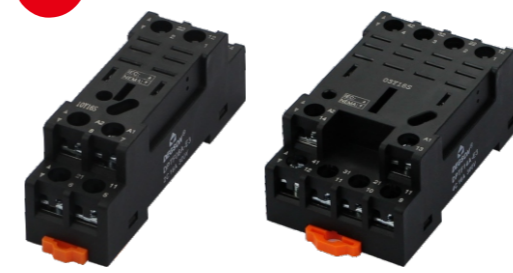
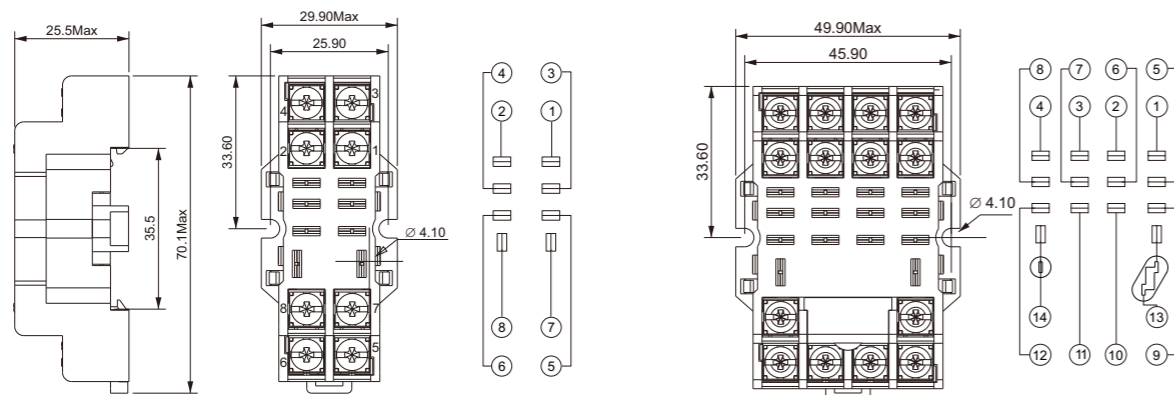

DPTF08A-E3

DPTF14A-E3

Features

- Protective socket, 16A.
- Green product RoHS.

DPTF 08A-E 3-00A (H)

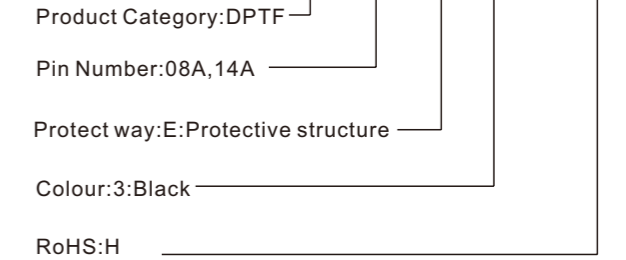

Performance Parameters

Technical parameters

Product type	DPTF08A-E3	DPTF14A-E3
Rated current	16A	
Rated voltage	300V	
Coil/Contact dielectric voltage	4000V/S	
Dielectric voltage between contact	2500V/S	
Screw torque	1.2Nm	
External connection wire	20-14AWG/0.5-2.5mm ²	
Ambient temperature	-40~+85°C	
Weight	46g	78g

Supporting relays and accessories

Product type	Relay	Module	Plastic pull clasp	Metal clamp spring
DPTF08A-E3	DRPL-2C	DMD	—	Wear
DPTF14A-E3	DRPL-4C	DND	—	Wear

Overall Dimensions, Wiring Diagrams

DPTF08A-E3

DPTF14A-E3

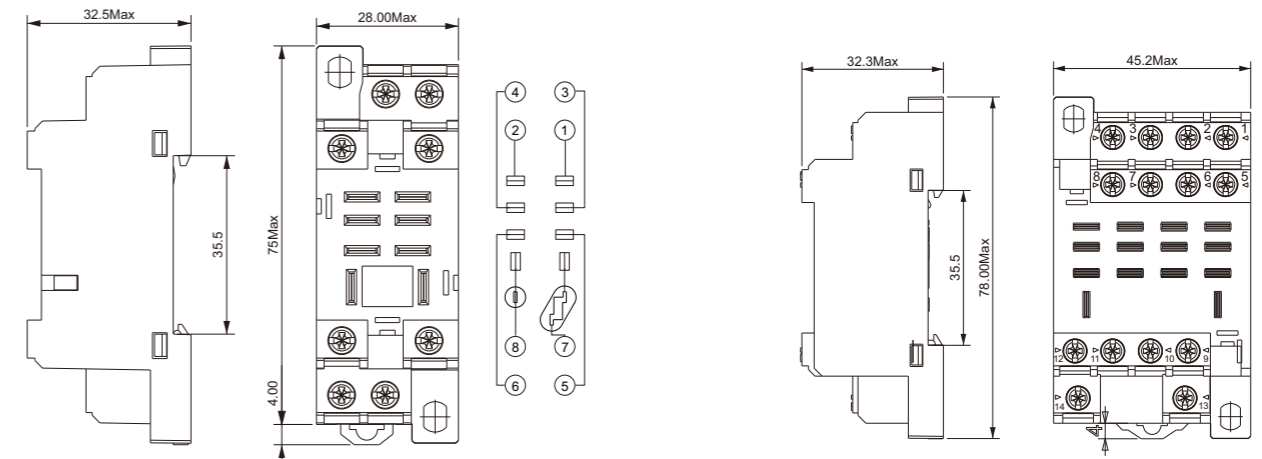

Features

- Small size, easy to install.
- You can select PNP, NPN according to the function mode of the controller.
- There is LED indicator light, you can see the working status of the product.
- IP67 level of protection.
- You can choose the material and length of the cable.

Product

Product	JB-M8-04-P-00	JB-M8-04-N-00	Product	JB-M8-04-P-00	JB-M8-04-N-00
Functional description	Split Plastic box, 4 channels, single signal, PNP	Split Plastic box, 4 channels, single signal, NPN	Functional description	Split Plastic box, 4 channels, single signal, PNP	Split Plastic box, 4 channels, single signal, NPN
Performance Parameter			I/O Parameters		
Signal type	PNP	NPN	Rated Voltage	24VDC	
Number of i/o channels	4		Rated Current	1.5A	
Number of signal output points	1		Interface type	M8 Female Acode 3P IEC 61076-2-104	
Shell material	PBT		Torque	0.2Nm(1.77Lb-In)	
Contact Material	Copper alloy		Interface material	Copper alloy	
Contact surface material	Au		Thread material	Ni	
Contact Material	PA		Mechanical Structure		
Contact Resistance	<10mΩ		Protection grade	IP67	
Power Supply Parameters			size(L X W X H)	86.6mm X 30.6mm X 27mm	
Supply Voltage	10...30VDC		Work Environment		
Supply Current MAX	Max 4A		Working temperature	-25...80°C	
Interface type	M12 Male Acode 8P IEC 61076-2-101		Storage temperature	-25...80°C	
Torque	0.4Nm(3.54Lb-In)		LED Status Indicator		
Interface material	Copper alloy		Power Lamp	Green LED	
Thread material	Ni		I/O Lamp	Yellow LED	

Cable																								
Product	PM-M12A-08P-FF-SL8A02-00A(H)	PM-M12A-08P-FF-SL8B02-00A(H)	PM-M12A-08P-FF-SR8A02-00A(H)	PM-M12A-08P-FF-SR8B02-00A(H)																				
Shell material	M12 * 1 Female Overmolded with Cable Plug, 8P, single end, Unshielded, Straight, PVC, 2m	M12 * 1 Female Overmolded with Cable Plug, 8P, single end, Unshielded, Straight, PUR, 2m	M12 * 1 Female Overmolded with Cable Plug, 8P, single end, Unshielded, Angled, PVC, 2m	M12 * 1 Female Overmolded with Cable Plug, 8P, single end, Unshielded, Angled, PUR, 2m																				
Cable																								
M12 Connector Pin drawing			<table border="1"> <thead> <tr> <th>NO.</th> <th>Color</th> <th>NO.</th> <th>Color</th> </tr> </thead> <tbody> <tr> <td>1</td> <td>White(WH)</td> <td>5</td> <td>Grey(GY)</td> </tr> <tr> <td>2</td> <td>Brown(BN)</td> <td>6</td> <td>Pink(PK)</td> </tr> <tr> <td>3</td> <td>Green(GN)</td> <td>7</td> <td>Blue(BU)</td> </tr> <tr> <td>4</td> <td>Yellow(YE)</td> <td>8</td> <td>Red(RD)</td> </tr> </tbody> </table>		NO.	Color	NO.	Color	1	White(WH)	5	Grey(GY)	2	Brown(BN)	6	Pink(PK)	3	Green(GN)	7	Blue(BU)	4	Yellow(YE)	8	Red(RD)
NO.	Color	NO.	Color																					
1	White(WH)	5	Grey(GY)																					
2	Brown(BN)	6	Pink(PK)																					
3	Green(GN)	7	Blue(BU)																					
4	Yellow(YE)	8	Red(RD)																					
M8 Pin drawing																								
Junction Box drawing																								
Wiring Diagram																								

Features

- Small size, easy to install.
- You can select PNP, NPN according to the function mode of the controller.
- There is LED indicator light, you can see the working status of the product.
- IP67 level of protection.
- You can choose the material and length of the cable.

Product

Product	JB-M8-06-P-00	JB-M8-06-N-00	Product	JB-M8-06-P-00	JB-M8-06-N-00
Functional description	Split Plastic box, 6 channels, single signal, PNP	Split Plastic box, 6 channels, single signal, PNP	Functional description	Split Plastic box, 6 channels, single signal, PNP	Split Plastic box, 6 channels, single signal, PNP
Performance Parameter			I/O Parameters		
Signal type	PNP	NPN	Rated Voltage	24VDC	
Number of i/o channels	6		Rated Current	1.5A	
Number of signal output points	1		Interface type	M8 Female Acode 3P IEC 61076-2-104	
Shell material	PBT		Torque	0.2Nm(1.77Lb-In)	
Contact Material	Copper alloy		Interface material	Copper alloy	
Contact surface material	Au		Thread material	Ni	
Contact Material	PA		Mechanical Structure		
Contact Resistance	<10mΩ		Protection grade	IP67	
Power Supply Parameters			size(L X W X H)	106.6mm X 30.6mm X 27mm	
Supply Voltage	10...30VDC		Work Environment		
Supply Current MAX	Max 4A		Working temperature	-25...80°C	
Interface type	M12 Male Acode 8P IEC 61076-2-101		Storage temperature	-25...80°C	
Torque	0.4Nm(3.54Lb-In)		LED Status Indicator		
Interface material	Copper alloy		Power Lamp	Green LED	
Thread material	Ni		I/O Lamp	Yellow LED	

Cable																								
Product	PM-M12A-08P-FF-SL8A02-00A(H)	PM-M12A-08P-FF-SL8B02-00A(H)	PM-M12A-08P-FF-SR8A02-00A(H)	PM-M12A-08P-FF-SR8B02-00A(H)																				
Shell material	M12 * 1 Female Overmolded with Cable Plug, 8P, single end, Unshielded, Straight, PVC, 2m	M12 * 1 Female Overmolded with Cable Plug, 8P, single end, Unshielded, Straight, PUR, 2m	M12 * 1 Female Overmolded with Cable Plug, 8P, single end, Unshielded, Angled, PVC, 2m	M12 * 1 Female Overmolded with Cable Plug, 8P, single end, Unshielded, Angled, PUR, 2m																				
Cable																								
M12 Connector Pin drawing			<table border="1"> <thead> <tr> <th>NO.</th> <th>Color</th> <th>NO.</th> <th>Color</th> </tr> </thead> <tbody> <tr> <td>1</td> <td>White(WH)</td> <td>5</td> <td>Grey(GY)</td> </tr> <tr> <td>2</td> <td>Brown(BN)</td> <td>6</td> <td>Pink(PK)</td> </tr> <tr> <td>3</td> <td>Green(GN)</td> <td>7</td> <td>Blue(BU)</td> </tr> <tr> <td>4</td> <td>Yellow(YE)</td> <td>8</td> <td>Red(RD)</td> </tr> </tbody> </table>		NO.	Color	NO.	Color	1	White(WH)	5	Grey(GY)	2	Brown(BN)	6	Pink(PK)	3	Green(GN)	7	Blue(BU)	4	Yellow(YE)	8	Red(RD)
NO.	Color	NO.	Color																					
1	White(WH)	5	Grey(GY)																					
2	Brown(BN)	6	Pink(PK)																					
3	Green(GN)	7	Blue(BU)																					
4	Yellow(YE)	8	Red(RD)																					
M8 Pin drawing																								
Junction Box drawing																								
Wiring Diagram	<p>JB-M8-06-P-00</p> <p>M8 Female Acode 3P</p>		<p>JB-M8-06-N-00</p> <p>M8 Female Acode 3P</p>																					

Features

- Small size, easy to install.
- You can select PNP, NPN according to the function mode of the controller.
- There is LED indicator light, you can see the working status of the product.
- IP67 level of protection.
- You can choose the material and length of the cable.

Product

Product	JB-M8-08-P-00	JB-M8-08-N-00	Product	JB-M8-08-P-00	JB-M8-08-N-00
Functional description	Split Plastic box, 8 channels, single signal, PNP	Split Plastic box, 8 channels, single signal, NPN	Functional description	Split Plastic box, 8 channels, single signal, PNP	Split Plastic box, 8 channels, single signal, NPN
Performance Parameter			I/O Parameters		
Signal type	PNP	NPN	Rated Voltage	24VDC	
Number of i/o channels	8		Rated Current	1.5A	
Number of signal output points	1		Interface type	M8 Female Acode 3P IEC 61076-2-104	
Shell material	PBT		Torque	0.2Nm(1.77Lb-In)	
Contact Material	Copper alloy		Interface material	Copper alloy	
Contact surface material	Au		Thread material	Ni	
Contact Material	PA		Mechanical Structure		
Contact Resistance	<10mΩ		Protection grade	IP67	
Power Supply Parameters			size(L X W X H)	126.6mm X 30.6mm X 27mm	
Supply Voltage	10...30VDC		Work Environment		
Supply Current MAX	Max 4A		Working temperature	-25...80°C	
Interface type	M12 Male Acode 12P IEC 61076-2-101		Storage temperature	-25...80°C	
Torque	0.4Nm(3.54Lb-In)		LED Status Indicator		
Interface material	Copper alloy		Power Lamp	Green LED	
Thread material	Ni		I/O Lamp	Yellow LED	

Cable																																
Product	PM-M12A-12P-FF-SL8A03-00A(H)	PM-M12A-12P-FF-SL8B03-00A(H)	PM-M12A-12P-FF-SR8A03-00A(H)	PM-M12A-12P-FF-SR8B03-00A(H)																												
Shell material	M12 * 1 Female Overmolded with Cable Plug, 12P, single end, Unshielded, Straight, PVC, 3m	M12 * 1 Female Overmolded with Cable Plug, 12P, single end, Unshielded, Straight, PUR, 3m	M12 * 1 Female Overmolded with Cable Plug, 12P, single end, Unshielded, Angled, PVC, 3m	M12 * 1 Female Overmolded with Cable Plug, 12P, single end, Unshielded, Angled, PUR, 3m																												
Cable																																
M12 Connector Pin drawing			<table border="1"> <thead> <tr> <th>NO.</th> <th>Color</th> <th>NO.</th> <th>Color</th> </tr> </thead> <tbody> <tr> <td>1</td> <td>Brown(BN)</td> <td>7</td> <td>Black (BK)</td> </tr> <tr> <td>2</td> <td>Blue(BU)</td> <td>8</td> <td>Grey(GY)</td> </tr> <tr> <td>3</td> <td>White(WH)</td> <td>9</td> <td>Red(RD)</td> </tr> <tr> <td>4</td> <td>Green(GN)</td> <td>10</td> <td>Violet(VT)</td> </tr> <tr> <td>5</td> <td>Pink(PK)</td> <td>11</td> <td>Grey/Pink(GY/PK)</td> </tr> <tr> <td>6</td> <td>Yellow(YE)</td> <td>12</td> <td>Red/Blue(RD/BU)</td> </tr> </tbody> </table>		NO.	Color	NO.	Color	1	Brown(BN)	7	Black (BK)	2	Blue(BU)	8	Grey(GY)	3	White(WH)	9	Red(RD)	4	Green(GN)	10	Violet(VT)	5	Pink(PK)	11	Grey/Pink(GY/PK)	6	Yellow(YE)	12	Red/Blue(RD/BU)
NO.	Color	NO.	Color																													
1	Brown(BN)	7	Black (BK)																													
2	Blue(BU)	8	Grey(GY)																													
3	White(WH)	9	Red(RD)																													
4	Green(GN)	10	Violet(VT)																													
5	Pink(PK)	11	Grey/Pink(GY/PK)																													
6	Yellow(YE)	12	Red/Blue(RD/BU)																													
M8 Pin drawing																																
Junction Box drawing																																
Wiring Diagram	JB-M8-08-P-00 		JB-M8-08-N-00 																													

Features

- Small size, easy to install.
- You can select PNP, NPN according to the function mode of the controller.
- There is LED indicator light, you can see the working status of the product.
- IP67 level of protection.
- You can choose the material and length of the cable.

Product

Product	JB-M8-10-P-00	JB-M8-10-N-00	Product	JB-M8-10-P-00	JB-M8-10-N-00
Functional description	Split Plastic box, 10 channels, single signal, PNP	Split Plastic box, 10 channels, single signal, PNP	Functional description	Split Plastic box, 10 channels, single signal, PNP	Split Plastic box, 10 channels, single signal, PNP
Performance Parameter			I/O Parameters		
Signal type	PNP	NPN	Rated Voltage	24VDC	
Number of i/o channels	10		Rated Current	1.5A	
Number of signal output points	1		Interface type	M8 Female Acode 3P IEC 61076-2-104	
Shell material	PBT		Torque	0.2Nm(1.77Lb-In)	
Contact Material	Copper alloy		Interface material	Copper alloy	
Contact surface material	Au		Thread material	Ni	
Contact Material	PA		Mechanical Structure		
Contact Resistance	<10mΩ		Protection grade	IP67	
Power Supply Parameters			size(L X W X H)	146.6mm X 30.6mm X 27mm	
Supply Voltage	10...30VDC		Work Environment		
Supply Current MAX	Max 4A		Working temperature	-25...80°C	
Interface type	M12 Male Acode 12P IEC 61076-2-101		Storage temperature	-25...80°C	
Torque	0.4Nm(3.54Lb-In)		LED Status Indicator		
Interface material	Copper alloy		Power Lamp	Green LED	
Thread material	Ni		I/O Lamp	Yellow LED	

Cable																																
Product	PM-M12A-12P-FF-SL8A02-00A(H)	PM-M12A-12P-FF-SL8B02-00A(H)	PM-M12A-12P-FF-SR8A02-00A(H)	PM-M12A-12P-FF-SR8B02-00A(H)																												
Shell material	M12 * 1 Female Overmolded with Cable Plug, 12P, single end, Unshielded, Straight, PVC, 3m	M12 * 1 Female Overmolded with Cable Plug, 12P, single end, Unshielded, Straight, PUR, 3m	M12 * 1 Female Overmolded with Cable Plug, 12P, single end, Unshielded, Angled, PVC, 3m	M12 * 1 Female Overmolded with Cable Plug, 12P, single end, Unshielded, Angled, PUR, 3m																												
Cable																																
M12 Connector Pin drawing			<table border="1"> <thead> <tr> <th>NO.</th> <th>Color</th> <th>NO.</th> <th>Color</th> </tr> </thead> <tbody> <tr> <td>1</td> <td>Brown(BN)</td> <td>7</td> <td>Black (BK)</td> </tr> <tr> <td>2</td> <td>Blue(BU)</td> <td>8</td> <td>Grey(GY)</td> </tr> <tr> <td>3</td> <td>White(WH)</td> <td>9</td> <td>Red(RD)</td> </tr> <tr> <td>4</td> <td>Green(GN)</td> <td>10</td> <td>Violet(VT)</td> </tr> <tr> <td>5</td> <td>Pink(PK)</td> <td>11</td> <td>Grey/Pink(GY/PK)</td> </tr> <tr> <td>6</td> <td>Yellow(YE)</td> <td>12</td> <td>Red/Blue(RD/BU)</td> </tr> </tbody> </table>		NO.	Color	NO.	Color	1	Brown(BN)	7	Black (BK)	2	Blue(BU)	8	Grey(GY)	3	White(WH)	9	Red(RD)	4	Green(GN)	10	Violet(VT)	5	Pink(PK)	11	Grey/Pink(GY/PK)	6	Yellow(YE)	12	Red/Blue(RD/BU)
NO.	Color	NO.	Color																													
1	Brown(BN)	7	Black (BK)																													
2	Blue(BU)	8	Grey(GY)																													
3	White(WH)	9	Red(RD)																													
4	Green(GN)	10	Violet(VT)																													
5	Pink(PK)	11	Grey/Pink(GY/PK)																													
6	Yellow(YE)	12	Red/Blue(RD/BU)																													
M8 Pin drawing																																
Junction Box drawing																																
Wiring Diagram	JB-M8-10-P-00 		JB-M8-10-N-00 																													

Features

- Small size, easy to install.
- You can select PNP, NPN according to the function mode of the controller.
- There is LED indicator light, you can see the working status of the product.
- IP67 level of protection.
- You can choose the material and length of the cable.

Product		
Product	JB-M8-04-P-A03-00	JB-M8-04-N-A03-00
Functional description	Pre-injected cable, plastic box, 4 channels, single signal, PNP, PVC, 3m	Pre-injected cable, plastic box, 4 channels, single signal, NPN, PVC, 3m
Performance Parameter		
Signal type	PNP	NPN
Number of i/o channels	4	
Number of signal output points	1	
Shell material	PBT	
Contact Material	Copper alloy	
Contact surface material	Au	
Contact Material	PA	
Contact Resistance	<10mΩ	
Cable material	PUR/PP, 5 million times	
Cable length	3m	
Power Supply Parameters		
Supply Voltage	10...30VDC	
Supply Current MAX	Max 4A	
I/O Parameters		
Rated Voltage	24VDC	
Rated Current	1.5A	
Interface type	M8 Female Acode 3P IEC 61076-2-104	
Torque	0.2Nm(1.77Lb-In)	
Interface material	Copper alloy	
Thread material	Ni	

Mechanical Structure

Protection grade	IP67
size(L X W X H)	86.6mm X 30.6mm X 18mm

Work Environment

Working temperature	-25...80°C
Storage temperature	-25...80°C

LED Status Indicator

Power Lamp	Green LED
I/O Lamp	Yellow LED

Product Figure

M8 Pin drawing

M8 Female Acode 3P

Junction Box drawing

JB-M8-04-P-A03-00

1	Un
3	0 V
4	Signal

JB-M8-04-N-A03-00

1	Un
3	0 V
4	Signal

Features

- Small size, easy to install.
- You can select PNP, NPN according to the function mode of the controller.
- There is LED indicator light, you can see the working status of the product.
- IP67 level of protection.
- You can choose the material and length of the cable.

Product		
Product	JB-M8-06-P-A03-00	JB-M8-06-N-A03-00
Functional description	Pre-injected cable, plastic box, 6 channels, single signal, PNP, PVC, 3m	Pre-injected cable, plastic box, 6 channels, single signal, NPN, PVC, 3m
Performance Parameter		
Signal type	PNP	NPN
Number of i/o channels	6	
Number of signal output points	1	
Shell material	PBT	
Contact Material	Copper alloy	
Contact surface material	Au	
Contact Material	PA	
Contact Resistance	<10mΩ	
Cable material	PUR/PP, 5 million times	
Cable length	3m	
Power Supply Parameters		
Supply Voltage	10...30VDC	
Supply Current MAX	Max 4A	
I/O Parameters		
Rated Voltage	24VDC	
Rated Current	1.5A	
Interface type	M8 Female Acode 3P IEC 61076-2-104	
Torque	0.2Nm(1.77Lb-In)	
Interface material	Copper alloy	
Thread material	Ni	

Mechanical Structure

Protection grade	IP67
size(L X W X H)	106.6mm X 30.6mm X 18mm

Work Environment

Working temperature	-25...80°C
Storage temperature	-25...80°C

LED Status Indicator

Power Lamp	Green LED
I/O Lamp	Yellow LED

Product Figure

M8 Pin drawing	<p>M8 Female Acode 3P</p>													
Junction Box drawing														
Wiring Diagram	<p>JB-M8-06-P-A03-00</p> <p>M8 Female Acode 3P</p> <table border="1"> <tr><td>1</td><td>Un</td></tr> <tr><td>3</td><td>0 V</td></tr> <tr><td>4</td><td>Signal</td></tr> </table>	1	Un	3	0 V	4	Signal	<p>JB-M8-06-N-A03-00</p> <p>M8 Female Acode 3P</p> <table border="1"> <tr><td>1</td><td>Un</td></tr> <tr><td>3</td><td>0 V</td></tr> <tr><td>4</td><td>Signal</td></tr> </table>	1	Un	3	0 V	4	Signal
1	Un													
3	0 V													
4	Signal													
1	Un													
3	0 V													
4	Signal													

Features

- Small size, easy to install.
- You can select PNP, NPN according to the function mode of the controller.
- There is LED indicator light, you can see the working status of the product.
- IP67 level of protection.
- You can choose the material and length of the cable.

Product		
Product	JB-M8-08-P-A03-00	JB-M8-08-N-A03-00
Functional description	Pre-injected cable, plastic box, 8 channels, single signal, PNP, PVC, 3m	Pre-injected cable, plastic box, 8 channels, single signal, NPN, PVC, 3m
Performance Parameter		
Signal type	PNP	NPN
Number of i/o channels	8	
Number of signal output points	1	
Shell material	PBT	
Contact Material	Copper alloy	
Contact surface material	Au	
Contact Material	PA	
Contact Resistance	<10mΩ	
Cable material	PUR/PP, 5 million times	
Cable length	3m	
Power Supply Parameters		
Supply Voltage	10...30VDC	
Supply Current MAX	Max 4A	
I/O Parameters		
Rated Voltage	24VDC	
Rated Current	1.5A	
Interface type	M8 Female Acode 3P IEC 61076-2-104	
Torque	0.2Nm(1.77Lb-In)	
Interface material	Copper alloy	
Thread material	Ni	

Mechanical Structure

Protection grade	IP67
size(L X W X H)	126.6mm X 30.6mm X 18mm

Work Environment

Working temperature	-25...80°C
Storage temperature	-25...80°C

LED Status Indicator

Power Lamp	Green LED
I/O Lamp	Yellow LED

Product Figure

M8 Pin drawing	<p>M8 Female Acode 3P</p>													
Junction Box drawing														
Wiring Diagram	<p>JB-M8-08-P-A03-00 M8 Female Acode 3P</p> <table border="1"> <tr><td>1</td><td>Un</td></tr> <tr><td>3</td><td>0 V</td></tr> <tr><td>4</td><td>Signal</td></tr> </table>	1	Un	3	0 V	4	Signal	<p>JB-M8-08-N-A03-00 M8 Female Acode 3P</p> <table border="1"> <tr><td>1</td><td>Un</td></tr> <tr><td>3</td><td>0 V</td></tr> <tr><td>4</td><td>Signal</td></tr> </table>	1	Un	3	0 V	4	Signal
1	Un													
3	0 V													
4	Signal													
1	Un													
3	0 V													
4	Signal													

Features

- Small size, easy to install.
- You can select PNP, NPN according to the function mode of the controller.
- There is LED indicator light, you can see the working status of the product.
- IP67 level of protection.
- You can choose the material and length of the cable.

Product		
Product	JB-M8-10-P-A03-00	JB-M8-10-N-A03-00
Functional description	Pre-injected cable, plastic box, 10 channels, single signal, PNP, PVC, 3m	Pre-injected cable, plastic box, 10 channels, single signal, NPN, PVC, 3m
Performance Parameter		
Signal type	PNP	NPN
Number of i/o channels	10	
Number of signal output points	1	
Shell material	PBT	
Contact Material	Copper alloy	
Contact surface material	Au	
Contact Material	PA	
Contact Resistance	<10mΩ	
Cable material	PUR/PP, 5 million times	
Cable length	3m	
Power Supply Parameters		
Supply Voltage	10...30VDC	
Supply Current MAX	Max 4A	
I/O Parameters		
Rated Voltage	24VDC	
Rated Current	1.5A	
Interface type	M8 Female Acode 3P IEC 61076-2-104	
Torque	0.2Nm(1.77Lb-In)	
Interface material	Copper alloy	
Thread material	Ni	

Mechanical Structure

Protection grade	IP67
size(L X W X H)	146.6mm X 30.6mm X 18mm

Work Environment

Working temperature	-25...80°C
Storage temperature	-25...80°C

LED Status Indicator

Power Lamp	Green LED
I/O Lamp	Yellow LED

Product Figure

M8 Pin drawing	<p>M8 Female Acode 3P</p>													
Junction Box drawing														
Wiring Diagram	<table border="1"> <tr><td>1</td><td>Un</td></tr> <tr><td>3</td><td>0V</td></tr> <tr><td>4</td><td>Signal</td></tr> </table> <p>JB-M8-10-P-A03-00 M8 Female Acode 3P</p>	1	Un	3	0V	4	Signal	<table border="1"> <tr><td>1</td><td>Un</td></tr> <tr><td>3</td><td>0V</td></tr> <tr><td>4</td><td>Signal</td></tr> </table> <p>JB-M8-10-N-A03-00 M8 Female Acode 3P</p>	1	Un	3	0V	4	Signal
1	Un													
3	0V													
4	Signal													
1	Un													
3	0V													
4	Signal													

Product	Functional description	Picture	Dimensional drawing	Wiring Diagram	Wiring List
PM-M8A-03P-MM-SL7A02-00A(H)	M12 * 1 Male Overmolded with Cable Plug, 3P, single end, Unshielded, Straight, PVC, 2m				1.BN 3.BU 4.BK
PM-M8A-03P-MM-SL7B02-00A(H)	M12 * 1 Male Overmolded with Cable Plug, 3P, single end, Unshielded, Straight, PUR, 2m				1.BN 3.BU 4.BK
PM-M8A-03P-MM-SR7A02-00A(H)	M12 * 1 Male Overmolded with Cable Plug, 3P, single end, Unshielded, Angled, PVC, 2m				1.BN 3.BU 4.BK
PM-M8A-03P-MM-SR7B02-00A(H)	M12 * 1 Male Overmolded with Cable Plug, 3P, single end, Unshielded, Angled, PUR, 2m				1.BN 3.BU 4.BK
PB-M8A-03P-MM-SL7001-00A(H)	M8 * 1 Male Field Assembly Plug, 3P, Unshielded, Screw Connection, Straight				/
PB-M8A-03P-MM-SL7001-00A(H)	M8 * 1 Female Field Assembly Plug, 3P, Unshielded, Screw Connection, Straight				/

Product	Functional description	Picture	Dimensional drawing	Wiring Diagram	Wiring List
PB-M12A-08P-MM-SL7001-00A(H)	M12 * 1 Male Field Assembly Plug, 8P, Unshielded, Screw Connection, Straight				/
PB-M12A-08P-MM-SR7001-00A(H)	M12 * 1 Male Field Assembly Plug, 8P, Unshielded, Screw Connection, Angled				/
PA-M12A-12P-MM-SL7001-00A(H)	M12 * 1 Male Field Assembly Plug, 12P, Unshielded, Soldering Connection, Straight				/
PA-M12A-12P-MM-SR7001-00A(H)	M12 * 1 Male Field Assembly Plug, 12P, Unshielded, Soldering Connection, Angled				/
SD-M12A-08P-FF-SF8A00-00A(H)	M12 * 1 Female Panel Mount Receptacle, 8P, Rear Mounting, With 2m wires				1.WH 2.BN 3.GN 4.YE 5.GY 6.PK 7.BU 8.RD
PA-M12A-12P-MM-SR7001-00A(H)	M12 * 1 Female Panel Mount Receptacle, 12P, Rear Mounting, With 2m wires				1.BN 2.BU 3.WH 4.GN 5.PK 6.YW 7.BK 8.GY 9.RD 10.VT 11.GY/PK 12.RD/BU

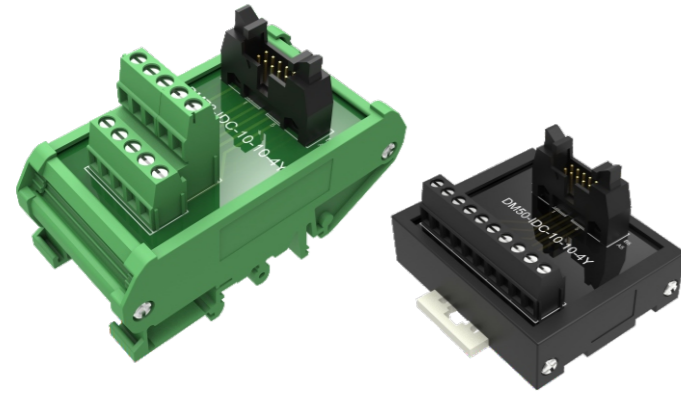

 DM72-IDC-10-10-4Y-00A(H)
 DM50-IDC-10-10-4Y-00A(H)

Features

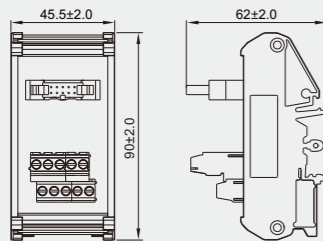
- This module is 10P IDC connector corresponding to 10P terminal blocks.
- Can be used to connect all with 10P IDC connector PLC or controller.
- Save wiring space, time and cost.
- Convenient for repair and maintenance.

Dimensions

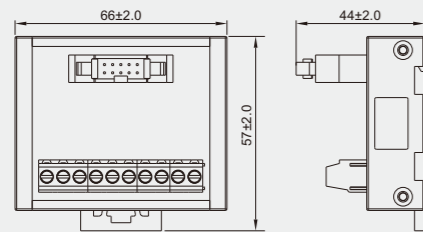
DM72-IDC-10-10-4Y-00A(H)



DM50-IDC-10-10-4Y-00A(H)

Performance Parameters

Rated Current/Voltage	1A/125VAC
Withstand Voltage	500VAC 1min
Insulation Resistance	500MΩ/500VDC
Stripping Length	7mm
Ambient Temperature	-20~+70°C
Maximum Torque	0.4Nm(3.54Lb-In)
Wire Range	26-12AWG
Mounting	35mm DIN

Suitable PLC

KEYENCE	KV-B16XA/XC KV series of small PLC
Panasonic FP0, FPΣ series	FP0-C16T/C16CT(IN Ministry) FP0-C16P/C16CP(IN Ministry) FP0-C32T/C32CT/T32CT(IN Ministry) FP0-C32P/C32CP/T32CP(IN Ministry) FP0-E16T/P(IN Ministry) FP0-E32T/P(IN Ministry) FP0-E8X FP0-E16X FPΣ-C28(IN Ministry) FPΣ-C32(IN Ministry) FP0-C16T/C16CT(OUT Ministry) FP0-C16P/C16CP(OUT Ministry) FP0-C32T/C32CT/T32CT(OUT Ministry) FP0-C32P/C32CP/T32CP(OUT Ministry) FP0-E16T/P(OUT Ministry) FP0-E32T/P(OUT Ministry) FP0-E8YT FP0-E16YT FPΣ-C28(OUT Ministry) FPΣ-C32(OUT Ministry)

Related Products

DX216-1 DX216-2 DX216-3 DX200-1 DX210-1

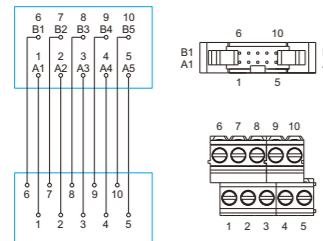
Circuit Diagram

DM72-IDC-10-10-4Y-00A(H)

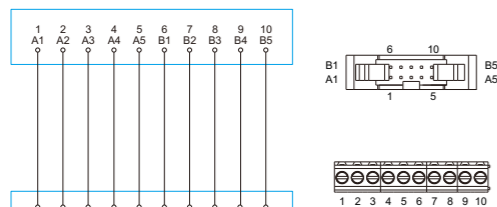

DM50-IDC-10-10-4Y-00A(H)

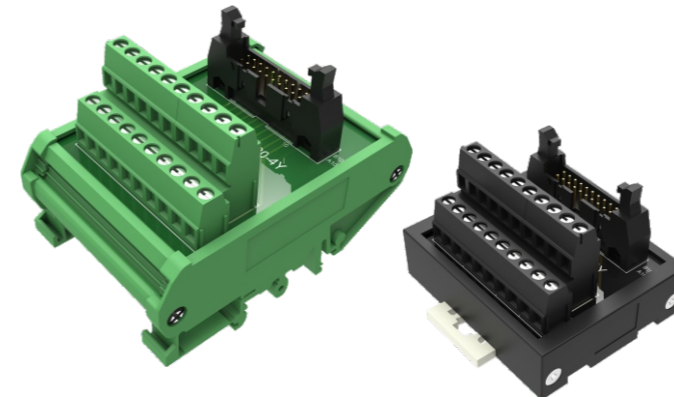

 DM72-IDC-20-20-4Y-00A(H)
 DM50-IDC-20-20-4Y-00A(H)

Features

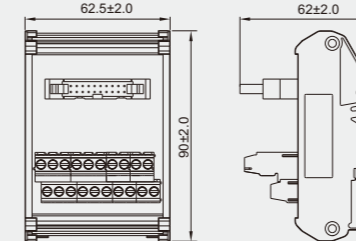
- This module is 20P IDC connector corresponding to 20P terminal blocks.
- Can be used to connect all with 20P IDC connector PLC or controller.
- Save wiring space, time and cost.
- Convenient for repair and maintenance.

Dimensions

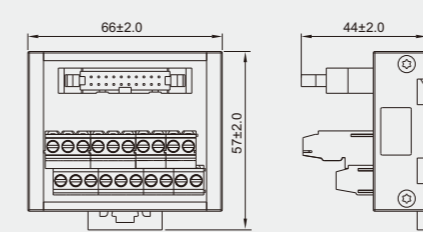
DM72-IDC-20-20-4Y-00A(H)

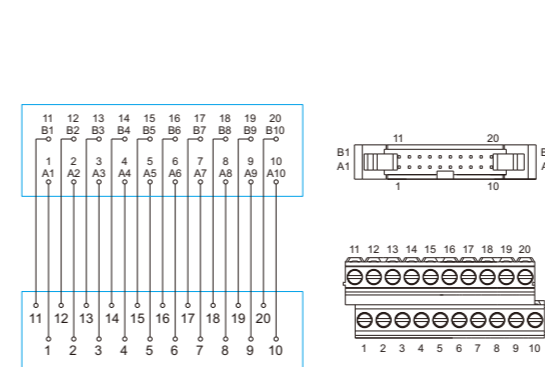

DM50-IDC-20-20-4Y-00A(H)

Circuit Diagram

 DM72-IDC-20-20-4Y-00A(H)
 DM50-IDC-20-20-4Y-00A(H)

Performance Parameters

Rated Current/Voltage	1A/125VAC
Withstand Voltage	500VAC 1min
Insulation Resistance	500MΩ/500VDC
Stripping Length	7mm
Ambient Temperature	-20~+70°C
Maximum Torque	0.4Nm(3.54Lb-In)
Wire Range	26-12AWG
Mounting	35mm DIN

Suitable PLC

OMRON	CJ1W-MD232 CJ1W-MD233
MITSUBISHI Fxseries	FX1NC-16MT FX1NC-32MT FX2NC-16MT FX2NC-32MT FX3UC-32MT FX2NC-16EX FX2NC-16EX-C FX2NC-16EXL-C FX2NC-16EYT FX2NC-17EYT-C FX2N-10PG FX2N-10GM FX2N-20GM

Related Products

DX200-2 DX210-2 DX218-1 DX220-3 DX218-9

26P IDC Interface Module

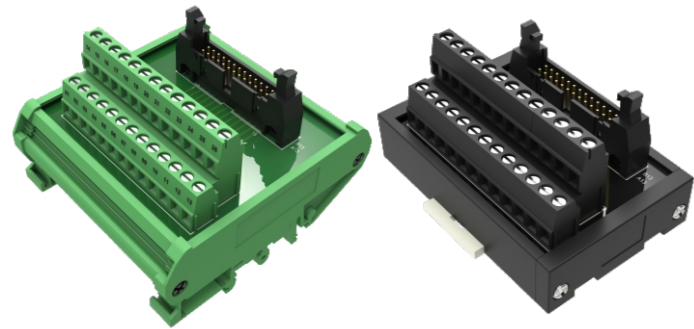

Features

- This module is 26P IDC connector corresponding to 26P terminal blocks.
- Can be used to connect all with 26P IDC connector PLC or controller.
- Save wiring space, time and cost.
- Convenient for repair and maintenance.

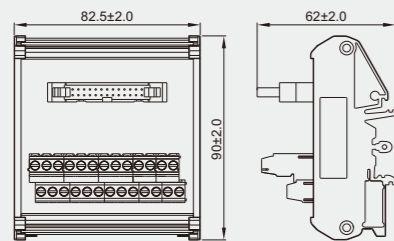
 DM72-IDC-26-26-4Y-00A(H)
 DM50-IDC-26-26-4Y-00A(H)

Dimensions

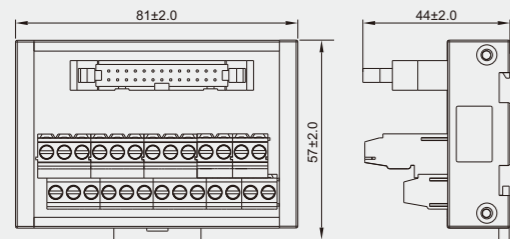
DM72-IDC-26-26-4Y-00A(H)



DM50-IDC-26-26-4Y-00A(H)

Performance Parameters

Rated Current/Voltage	1A/125VAC
Withstand Voltage	500VAC 1min
Insulation Resistance	500MΩ/500VDC
Stripping Length	7mm
Ambient Temperature	-20~+70°C
Maximum Torque	0.4Nm(3.54Lb-In)
Wire Range	26-12AWG
Mounting	35mm DIN

Suitable PLC

KEYENCE

 KL-16CX
 KL-16CT
 KL-32CX
 KL-32CT

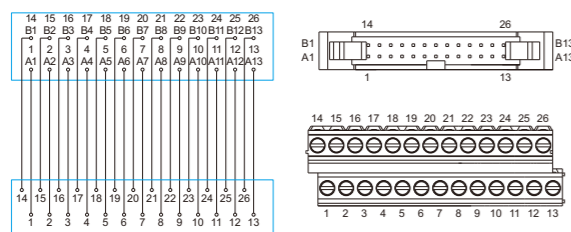
Circuit Diagram

 DM72-IDC-26-26-4Y-00A(H)
 DM50-IDC-26-26-4Y-00A(H)

Related Products

DX200-26 DX210-6 DX220-2

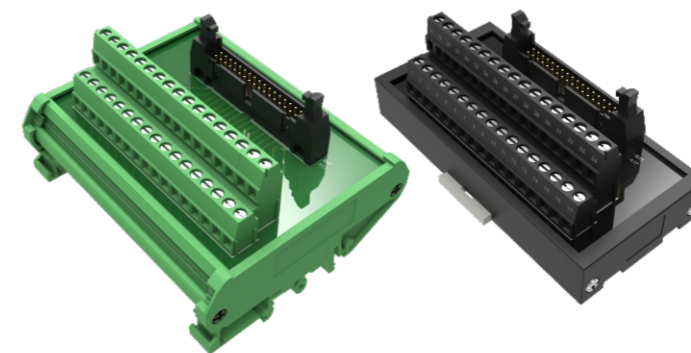
34P IDC Interface Module



Features

- This module is 34P IDC connector corresponding to 34P terminal blocks.
- Can be used to connect all with 34P IDC connector PLC or controller.
- Save wiring space, time and cost.
- Convenient for repair and maintenance.

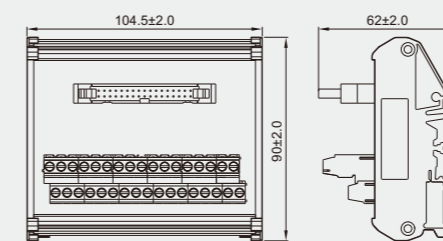
 DM72-IDC-34-34-4Y-00A(H)
 DM50-IDC-34-34-4Y-00A(H)

Dimensions

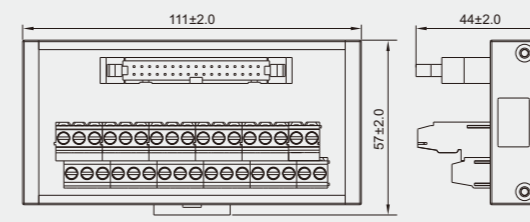
DM72-IDC-34-34-4Y-00A(H)



DM50-IDC-34-34-4Y-00A(H)

Performance Parameters

Rated Current/Voltage	1A/125VAC
Withstand Voltage	500VAC 1min
Insulation Resistance	500MΩ/500VDC
Stripping Length	7mm
Ambient Temperature	-20~+70°C
Maximum Torque	0.4Nm(3.54Lb-In)
Wire Range	26-12AWG
Mounting	35mm DIN

Suitable PLC

KEYENCE

 KL- C32XA/C
 KL- C64XA/C
 KL- C32TA/C
 KL- C64TA/C

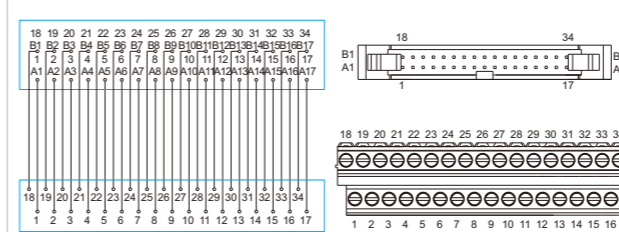
Circuit Diagram

 DM72-IDC-34-34-4Y-00A(H)
 DM50-IDC-34-34-4Y-00A(H)

Related Products

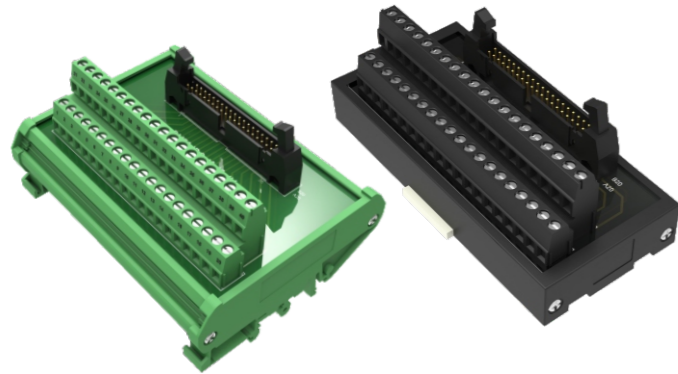
DX200-3 DX210-3



DM72-IDC-40-40-4Y-00A(H)
DM50-IDC-40-40-4Y-10A(H)

Features

- This module is 40P IDC connector corresponding to 40P terminal blocks.
- Can be used to connect all with 40P IDC connector PLC or controller.
- Save wiring space, time and cost.
- Convenient for repair and maintenance.

Dimensions

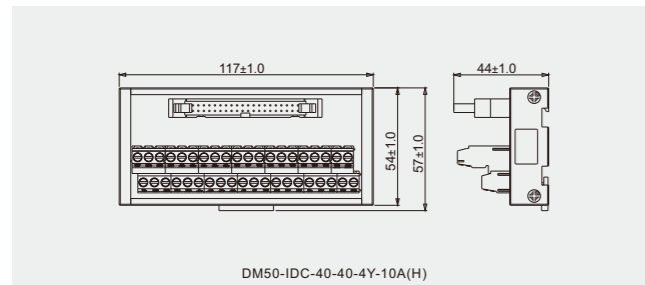
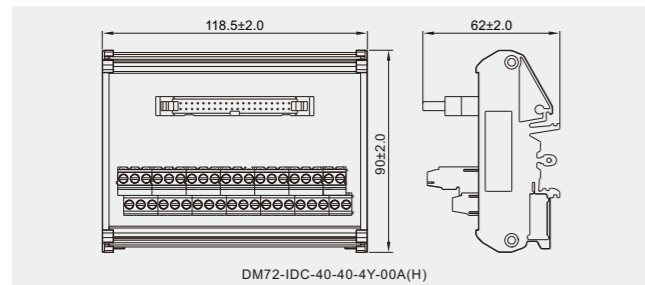

Performance Parameters

Rated Current/Voltage	1A/125VAC
Withstand Voltage	500VAC 1min
Insulation Resistance	500MΩ/500VDC
Stripping Length	7mm
Ambient Temperature	-20~+70°C
Maximum Torque	0.4Nm(3.54Lb-In)
Wire Range	26-12AWG
Mounting	35mm DIN

Suitable PLC

KEYENCE	KV-1000 / KV-3000 / KV-5000 KV-H20S / KV-H40S
OMRON	CJ1W-ID231 / CJ1W-ID261 CJ1W-MD261(IN terminal) CJ1W-ID232 / CJ1W-ID262 CJ1W-MD263(IN terminal) CJ1W-MD563(IN terminal) CJ1W-OD231 / CJ1W-OD261 CJ1W-MD261(OUT terminal) CJ1W-OD232 / CJ1W-OD233 CJ1W-OD262 / CJ1W-OD263 CJ1W-MD263(OUT terminal) CJ1W-MD563(OUT terminal) CJ1M-CPU21 CJ1M-CPU22 CJ1M-CPU23
MITSUBISHI Qseries	Qx41 QX41-S1 Qx42 QX42-S1 Qx71 QX72 QY41P QY42P Qy71 QH42P QD70P4 QD70P QD70D QD75M
Panasonic FP0, FPΣ, FP2 series	FP2-XT64D2T/P FP2-C1D FP2-X32D2 FP2-X64D2 FP2-32T/P FP2-Y64T/P FP2-XY64D2T/XY64D7T FP2-XY64D2P/XY64D7P FP2-PP21 FP2-PP22 FP2-PP41 FP2-PP42 FP2-HSCT FP2-PXYT
SIEMENS	40P Plug with a full range
Yokogawa PLCFA-M3 series	F3WD64-3N F3WD64-3F F3WD32-3F

Circuit Diagram

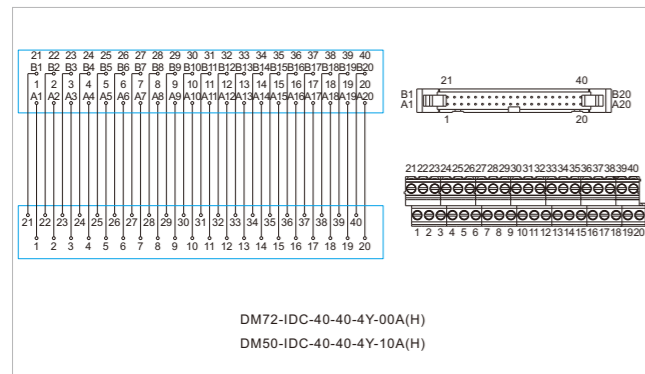

Related Products

- DX217-1 DX217-2 DX212-1 DX219-2 DX200-4
DX210-4 DX210-5

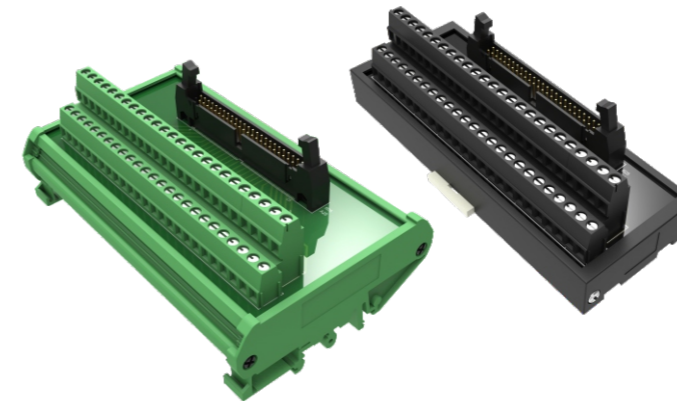

DM72-IDC-50-50-4Y-00A(H)
DM50-IDC-50-50-4Y-00A(H)

Features

- This module is 50P IDC connector corresponding to 50P terminal blocks.
- Can be used to connect all with 50P IDC connector PLC or controller.
- Save wiring space, time and cost.
- Convenient for repair and maintenance.

Dimensions

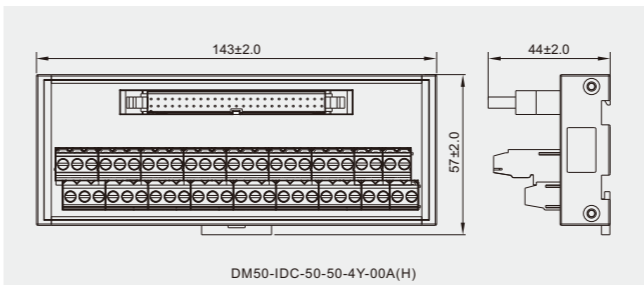
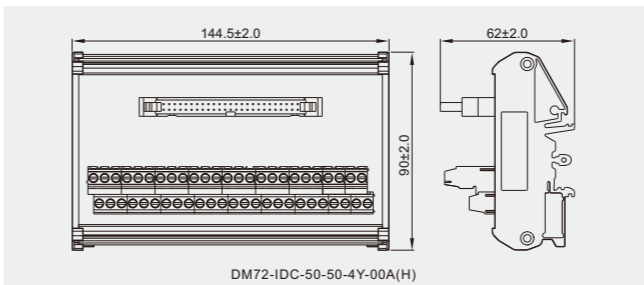

Performance Parameters

Rated Current/Voltage	1A/125VAC
Withstand Voltage	500VAC 1min
Insulation Resistance	500MΩ/500VDC
Stripping Length	7mm
Ambient Temperature	-20~+70°C
Maximum Torque	0.4Nm(3.54Lb-In)
Wire Range	26-12AWG
Mounting	35mm DIN

Suitable PLC

—	—
---	---

Circuit Diagram

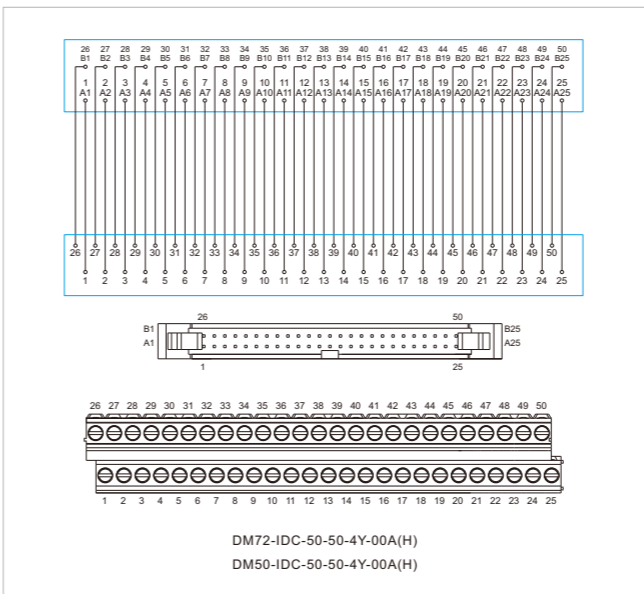

Related Products

—	—
---	---



DM50-IDC-20-20-4G-00A(H)

Features

- This module is 20P IDC connector corresponding to 20P barrier terminal blocks.
- Can be used to connect all with 20P IDC connector PLC or controller.
- Save wiring space, time and cost.
- Convenient for repair and maintenance.

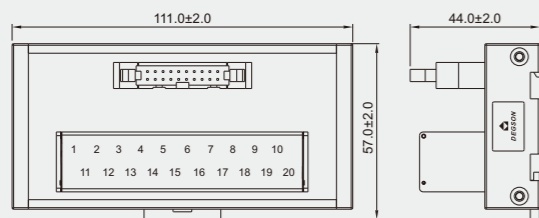
Dimensions

DM50-IDC-20-20-4G-00A(H)

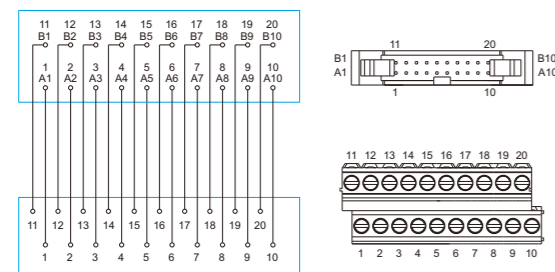
Circuit Diagram

DM50-IDC-20-20-4G-00A(H)

Performance Parameters

Rated Current/Voltage	1A/125VAC
Withstand Voltage	500VAC 1min
Insulation Resistance	500MΩ/ 500VDC
Stripping Length	7mm
Ambient Temperature	-20~+70°C
Maximum Torque	4.43Lb-In
Wire Range	22-14AWG
Mounting	35mm DIN

Suitable PLC

OMRON	CJ1W-MD232 CJ1W-MD233
MITSUBISHI Fxseries	FX1NC-16MT FX1NC-32MT FX2NC-16MT FX2NC-32MT FX3UC-32MT FX2NC-16EX FX2NC-16EX-C FX2NC-16EXL-C FX2NC-16EYT FX2NC-17EYT-C FX2N-10PG FX2N-10GM FX2N-20GM

Related Products

DX200-2 DX210-2 DX218-1 DX220-3 DX218-9



DM50-IDC-40-40-4G-00A(H)

Features

- This module is 40P IDC connector corresponding to 40P barrier terminal blocks.
- Can be used to connect all with 40P IDC connector PLC or controller.
- Save wiring space, time and cost.
- Convenient for repair and maintenance.

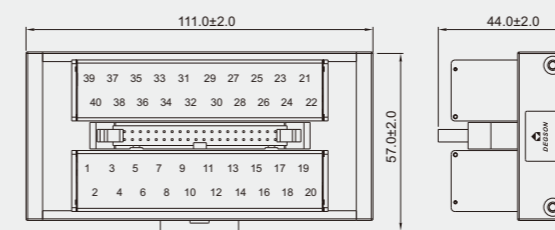
Dimensions

DM50-IDC-40-40-4G-00A(H)

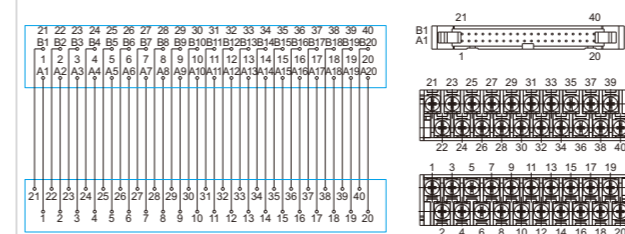
Circuit Diagram

DM50-IDC-40-40-4G-00A(H)

Related Products

 DX217-1 DX217-2 DX212-1 DX219-2 DX200-4
DX210-4 DX210-5

Performance Parameters

Rated Current/Voltage	1A/125VAC
Withstand Voltage	500VAC 1min
Insulation Resistance	500MΩ/ 500VDC
Stripping Length	7mm
Ambient Temperature	-20~+70°C
Maximum Torque	4.43Lb-In
Wire Range	22-14AWG
Mounting	35mm DIN

Suitable PLC

KEYENCE	KV-1000 / KV-3000 / KV-5000 KV-H20S / KV-H40S
OMRON	CJ1W-ID231 / CJ1W-ID261 CJ1W-MD261(IN terminal) CJ1W-ID232 / CJ1W-ID262 CJ1W-MD263(IN terminal) CJ1W-MD563(IN terminal) CJ1W-OD231 / CJ1W-OD261 CJ1W-MD261(OUT terminal) CJ1W-OD232 / CJ1W-OD233 CJ1W-OD262 / CJ1W-OD263 CJ1W-MD263(OUT terminal) CJ1W-MD563(OUT terminal) CJ1M-CPU21 CJ1M-CPU22 CJ1M-CPU23
MITSUBISHI Qseries	Qx41 QX41-S1 Qx42 QX42-S1 Qy71 Qx72 Qy41P QY42P Qy71 QH42P QD70P4 QD70P QD70D QD75M
Panasonic FP0, FPΣ, FP2 series	FP2-XT64D2T/P FP2-C1D FP2-X32D2 FP2-X64D2 FP2-32T/P FP2-Y64T/P FP2-XY64D2T/XY64D7T FP2-XY64D2P/XY64D7P FP2-PP21 FP2-PP22 FP2-PP41 FP2-PP42 FP2-HSCT FP2-PXYT
SIEMENS	40P Plug with a full range
Yokogawa PLCFA-M3 series	F3WD64-3N F3WD64-3F F3WD32-3F

20、26、36、50P MDR Interface Module

CE RoHS

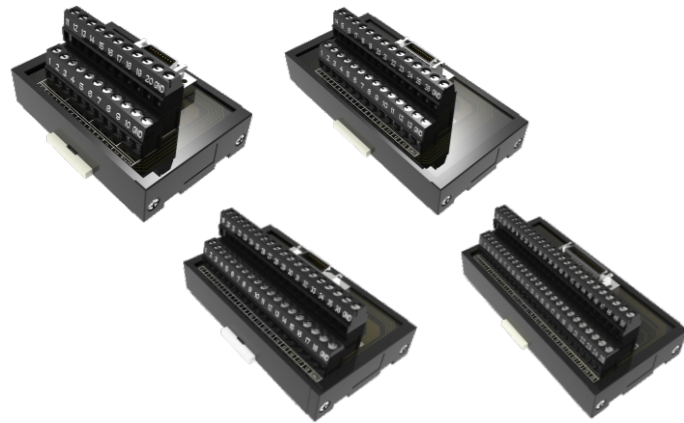

Features

- Including 20P, 26P, 36P, 50P MDR Interface module.
- Can be directly used in Mitsubishi, Yaskawa, Panasonic, Delta, Sanyo, AB servo driver signal interface.
- No need for welding wire, just one to one pin wiring.
- Save wiring space, time and cost.
- Convenient for repair and maintenance.

DM50-MDR-20-20-4Y-00A(H) DM50-MDR-26-26-4Y-00A(H)
DM50-MDR-36-36-4Y-00A(H) DM50-MDR-50-50-4Y-00A(H)

Dimensions

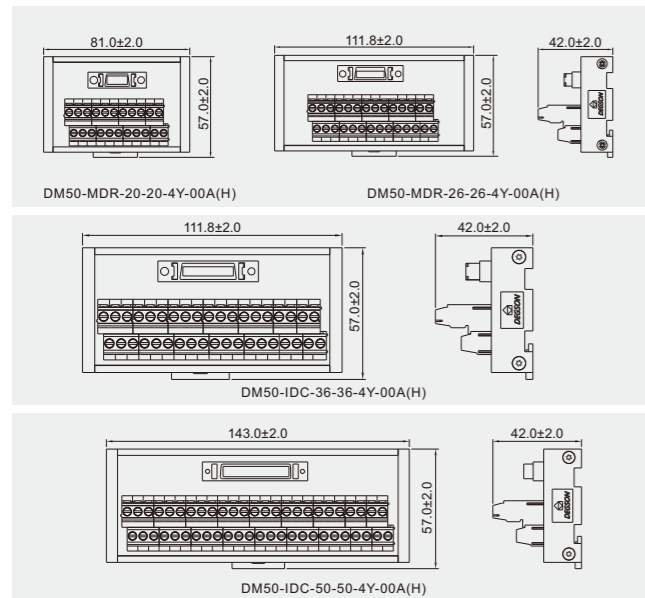

Performance Parameters

Rated Current/Voltage	1A/125VAC
Withstand Voltage	500VAC 1min
Insulation Resistance	500MΩ/500VDC
Stripping Length	7mm
Ambient Temperature	-20~+70°C
Maximum Torque	0.4Nm(3.54Lb-In)
Wire Range	26-12AWG
Mounting	35mm DIN

Suitable

PANASONIC DELTA KEYENCE SANYO YASKWA AB FUJI MITSUBISHI

Related Products

DX220-1 DX220-2 DX220-3

Circuit Diagram

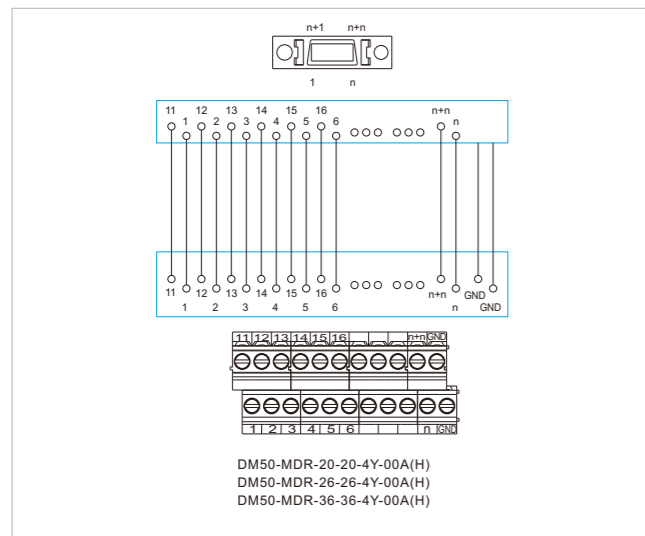

Circuit Diagram

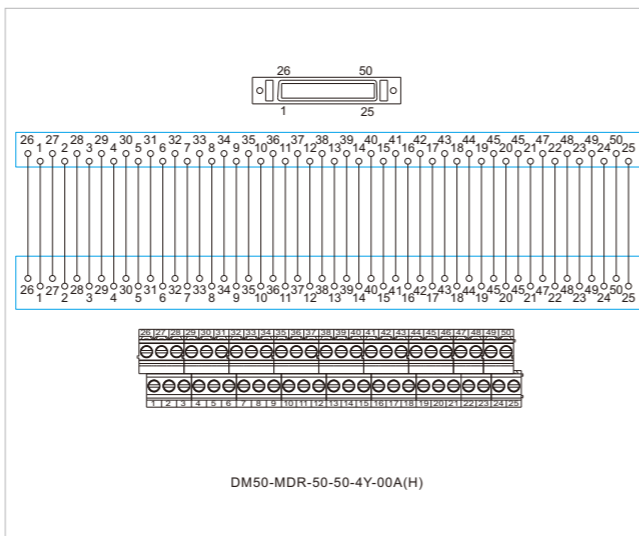

40P FCN Interface Module

CE RoHS



DM50-FCN-40-40-4Y-00A(H)

Features

- This module is 40P FCN Interface module.
- Can be used to connect various brands of servo or PLC controller.
- Save wiring space, time and cost.
- Convenient for repair and maintenance.

Dimensions

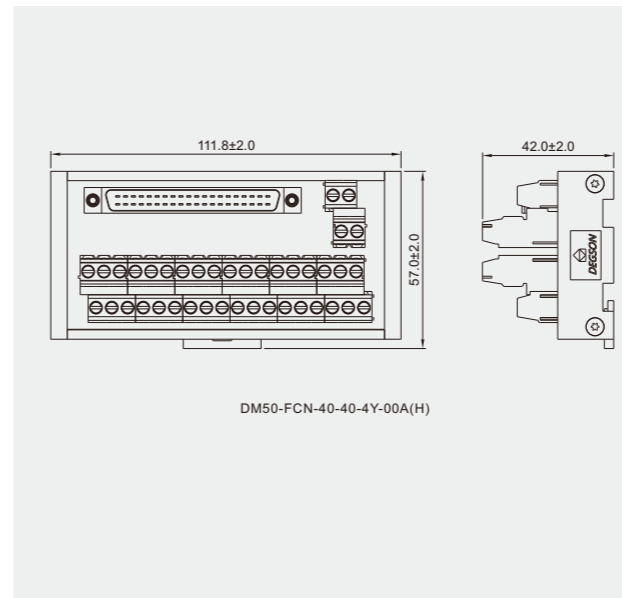

Performance Parameters

Rated Current/Voltage	1A/125VAC
Withstand Voltage	500VAC 1min
Insulation Resistance	500MΩ/500VDC
Stripping Length	7mm
Ambient Temperature	-20~+70°C
Maximum Torque	0.4Nm(3.54Lb-In)
Wire Range	26-12AWG
Mounting	35mm DIN

Suitable PLC



Circuit Diagram

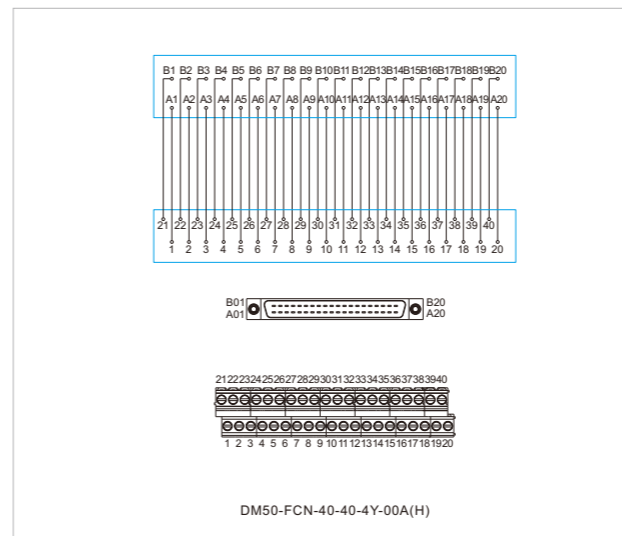

Related Products

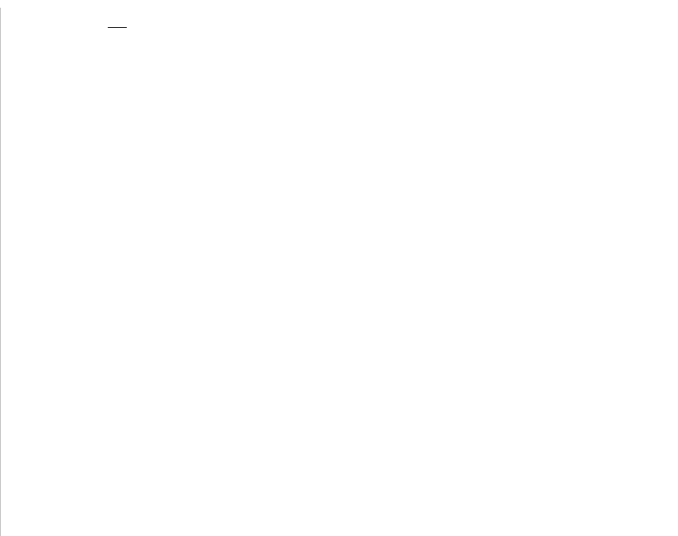

Small D-SUB Female Interface Module

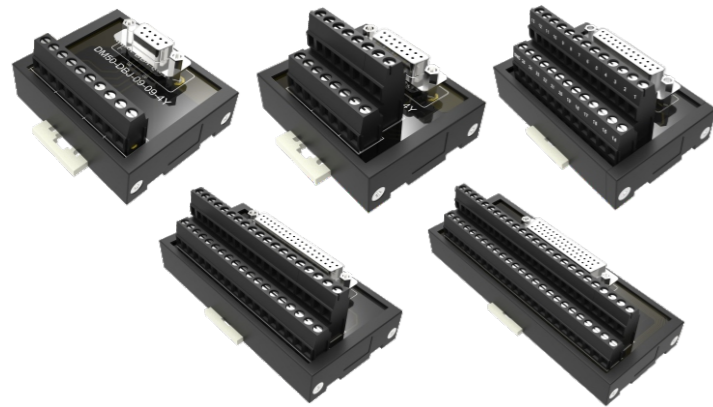

Features

- Including 9P, 15P, 25P, 37P, 50P D-SUB female splitter.
- Can be connected to a variety of servo drivers, motion control CARDS, touch screens, CNC systems etc.
- Save wiring space, time and cost.
- Convenient for repair and maintenance.

DM50-DBJ-09-09-4Y-00A(H) DM50-DBJ-15-15-4Y-00A(H)
 DM50-DBJ-25-25-4Y-00A(H) DM50-DBJ-37-37-4Y-00A(H)
 DM50-DBJ-50-50-4Y-00A(H)

Dimensions

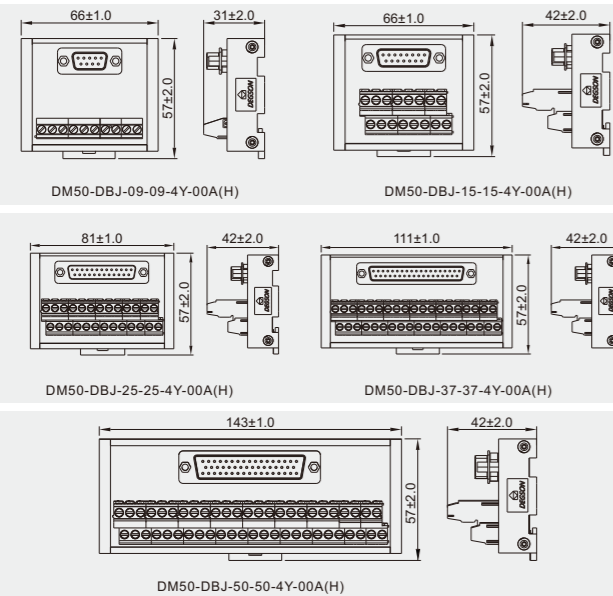

Performance Parameters

Rated Current/Voltage	1A/125VAC
Withstand Voltage	500VAC 1min
Insulation Resistance	500MΩ/500VDC
Stripping Length	7mm
Ambient Temperature	-20~+70°C
Maximum Torque	0.4Nm(3.54Lb-In)
Wire Range	26-12AWG
Mounting	35mm DIN

Circuit Diagram

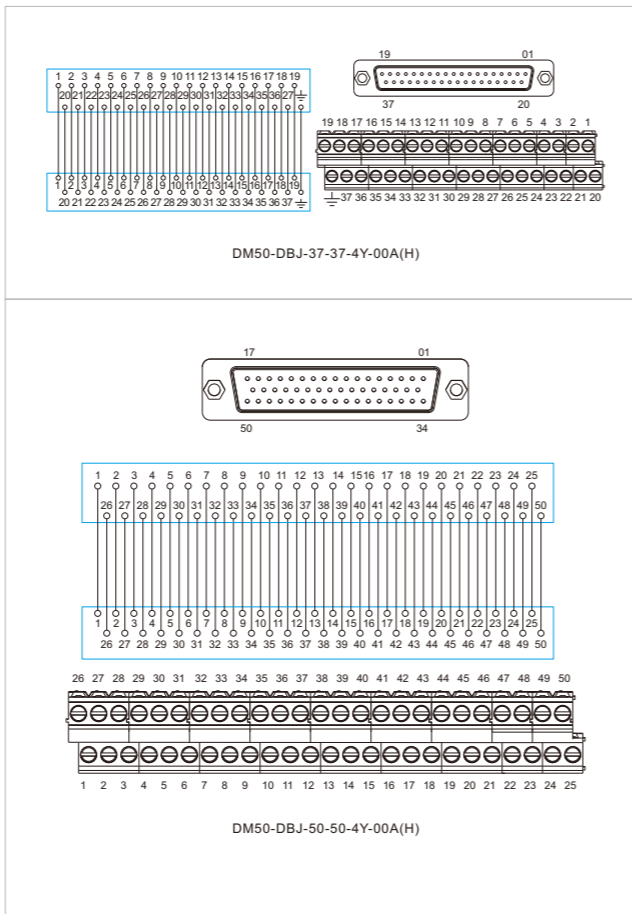

Circuit Diagram

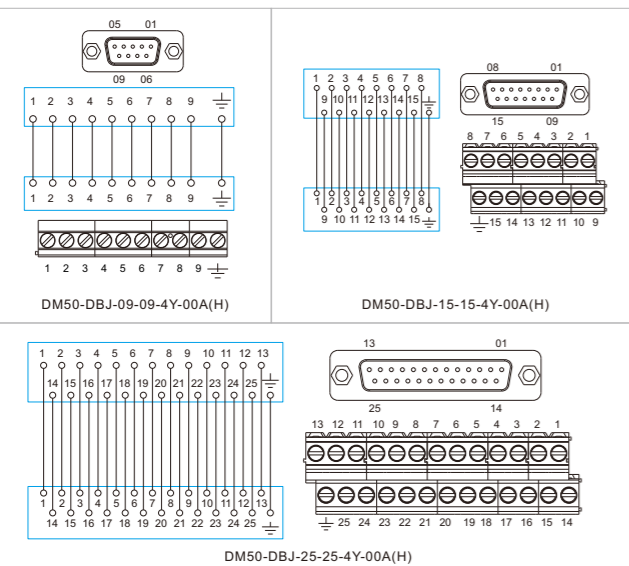

Small D-SUB Male Interface Module

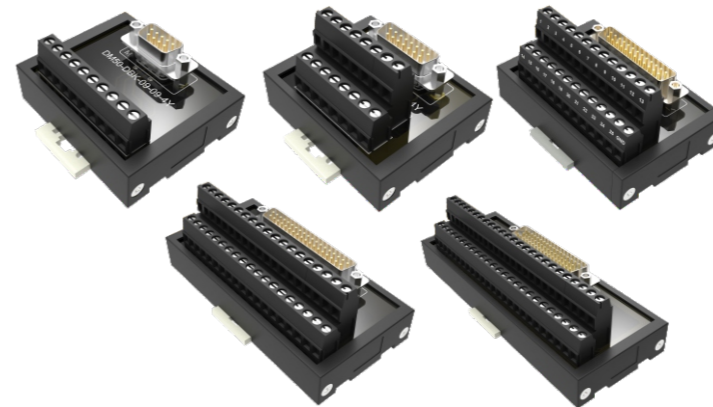

Features

- Including 9P, 15P, 25P, 37P, 50P D-SUB male splitter.
- Can be connected to a variety of servo drivers, motion control CARDS, touch screens, CNC systems etc.
- Save wiring space, time and cost.
- Convenient for repair and maintenance.

DM50-DBK-09-09-4Y-00A(H) DM50-DBK-15-15-4Y-00A(H)
 DM50-DBK-25-25-4Y-00A(H) DM50-DBK-37-37-4Y-00A(H)
 DM50-DBK-50-50-4Y-00A(H)

Dimensions

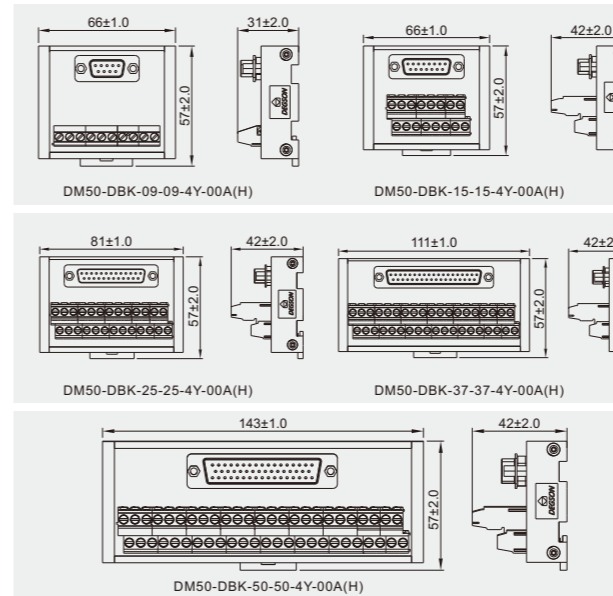

Performance Parameters

Rated Current/Voltage	1A/125VAC
Withstand Voltage	500VAC 1min
Insulation Resistance	500MΩ/500VDC
Stripping Length	7mm
Ambient Temperature	-20~+70°C
Maximum Torque	0.4Nm(3.54Lb-In)
Wire Range	26-12AWG
Mounting	35mm DIN

Circuit Diagram

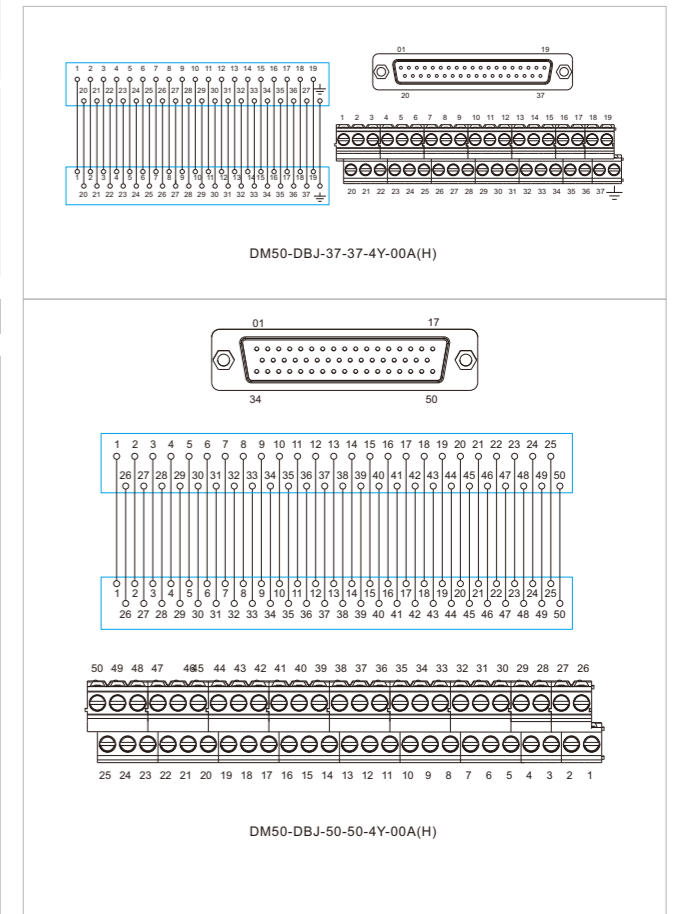

Circuit Diagram

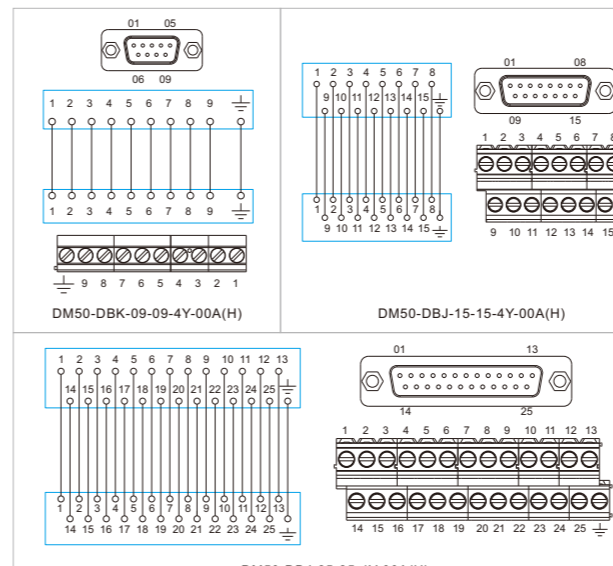

D-SUB Female Interface Module

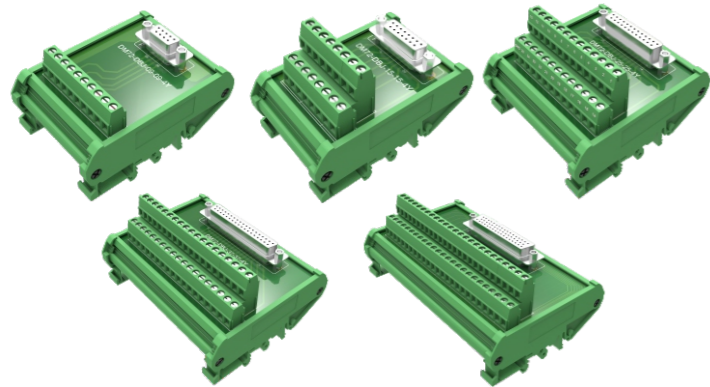

Features

- Including 9P, 15P, 25P, 37P, 50P D-SUB female splitter.
- Can be connected to a variety of servo drivers, motion control CARDS, touch screens, CNC systems etc.
- Save wiring space, time and cost.
- Convenient for repair and maintenance.

DM72-DBJ-09-09-4Y-00A(H) DM72-DBJ-15-15-4Y-00A(H)
 DM72-DBJ-25-25-4Y-00A(H) DM72-DBJ-37-37-4Y-00A(H)
 DM72-DBJ-50-50-4Y-00A(H)

Dimensions

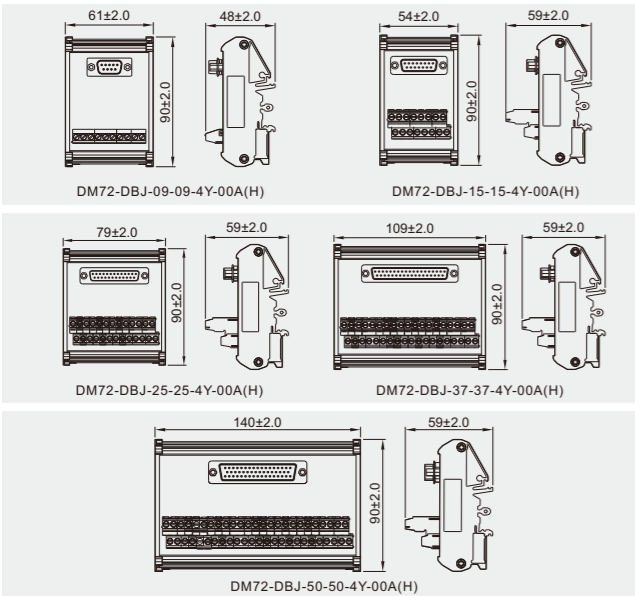

Performance Parameters

Rated Current/Voltage	1A/125VAC
Withstand Voltage	500VAC 1min
Insulation Resistance	500MΩ/500VDC
Stripping Length	7mm
Ambient Temperature	-20~+70°C
Maximum Torque	0.4Nm(3.54Lb-In)
Wire Range	26-12AWG
Mounting	35mm DIN

Circuit Diagram

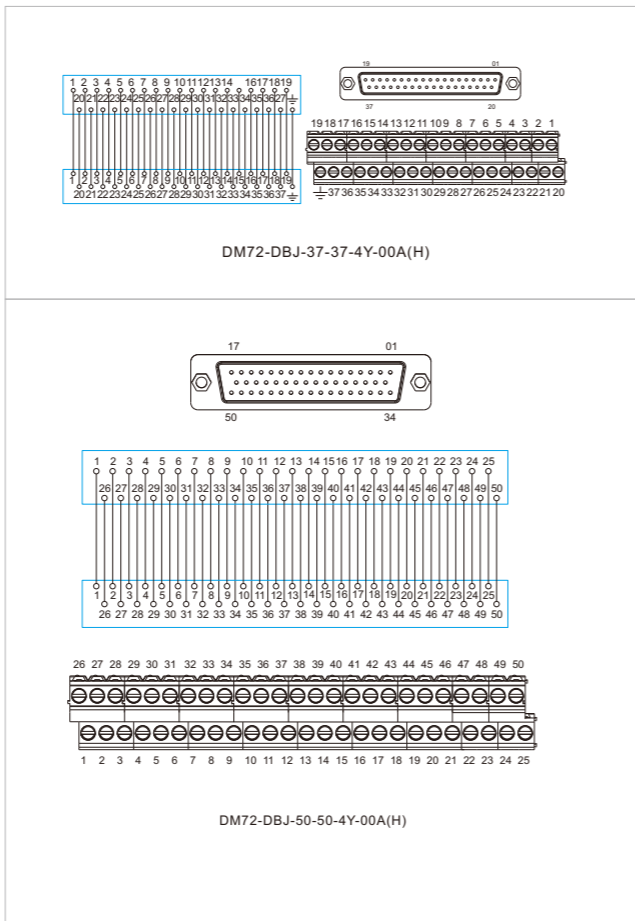

Circuit Diagram

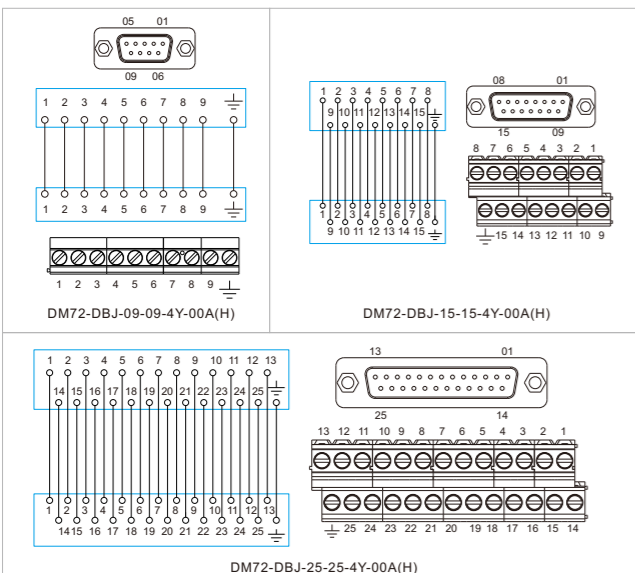

D-SUB Male Interface Module

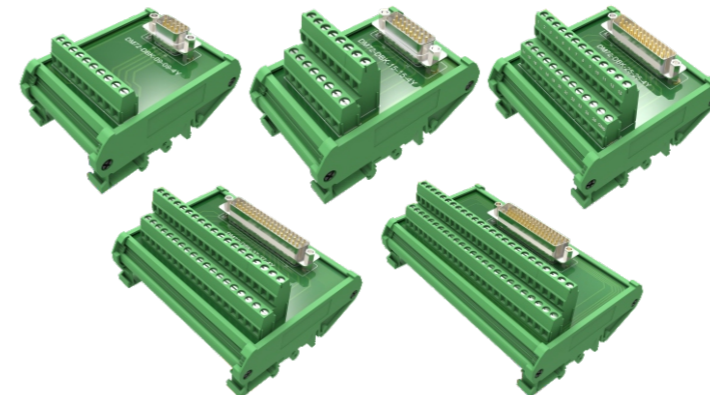

Features

- Including 9P, 15P, 25P, 37P, 50P D-SUB male splitter.
- Can be connected to a variety of servo drivers, motion control CARDS, touch screens, CNC systems etc.
- Save wiring space, time and cost.
- Convenient for repair and maintenance.

DM72-DBK-09-09-4Y-00A(H) DM72-DBK-15-15-4Y-00A(H)
 DM72-DBK-25-25-4Y-00A(H) DM72-DBK-37-37-4Y-00A(H)
 DM72-DBK-50-50-4Y-00A(H)

Dimensions

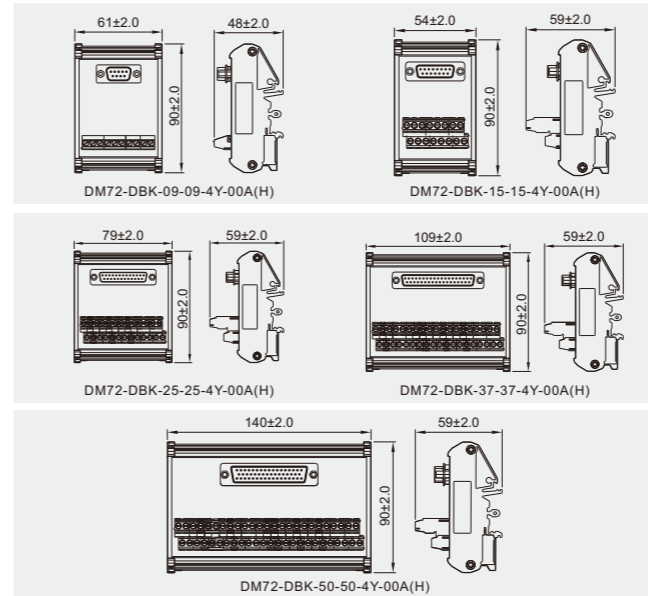

Performance Parameters

Rated Current/Voltage	1A/125VAC
Withstand Voltage	500VAC 1min
Insulation Resistance	500MΩ/500VDC
Stripping Length	7mm
Ambient Temperature	-20~+70°C
Maximum Torque	0.4Nm(3.54Lb-In)
Wire Range	26-12AWG
Mounting	35mm DIN

Circuit Diagram

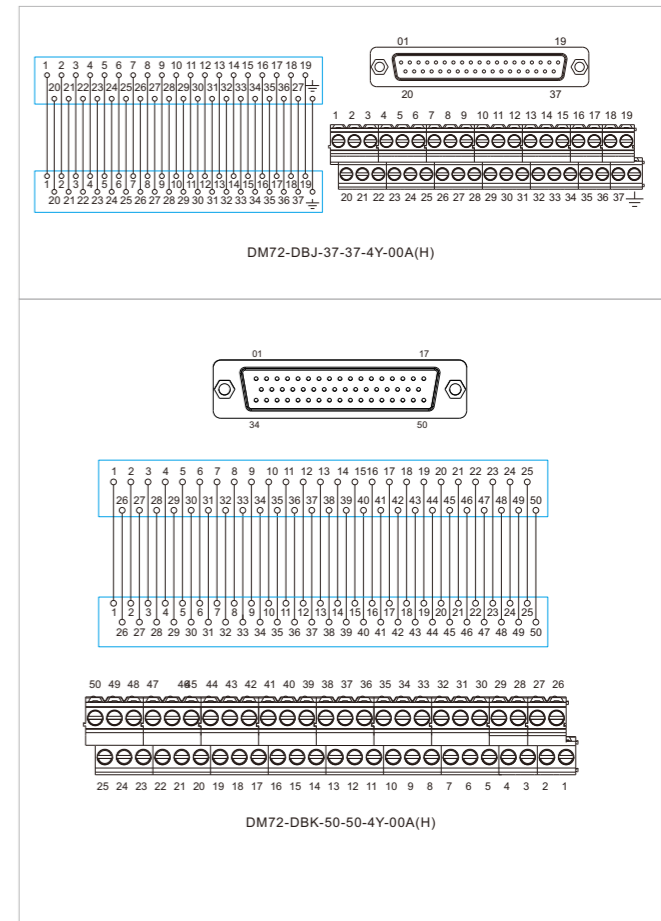

Circuit Diagram

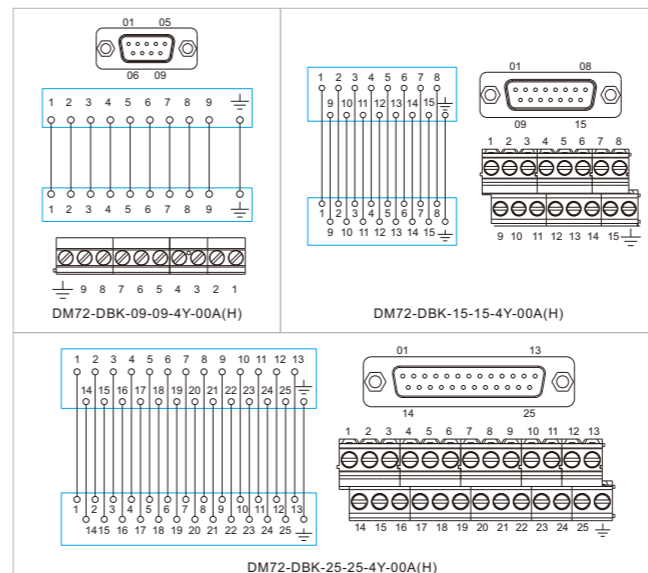

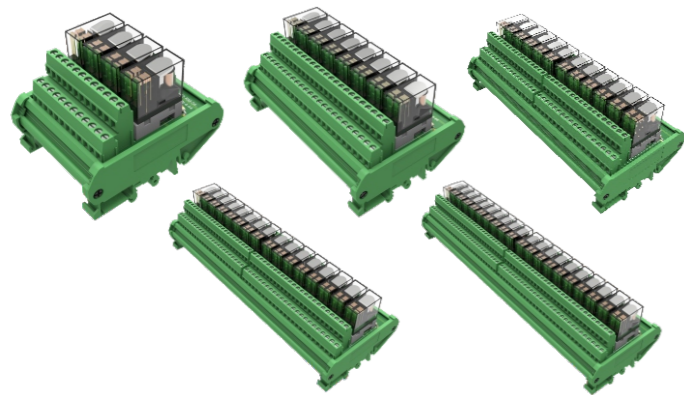
Features

- Including 4, 8, 12, 16, 20 bit independent relay circuits.
- Applicable to NPN, PNP controller.
- The relay adopts 2C/O node and 1 to 1 output of the output end.
- Save wiring space, time and cost.
- Convenient for repair and maintenance.

DM72-RM-04-PN-4-44-11A(H) DM72-RM-08-PN-4-44-11A(H)
 DM72-RM-12-PN-4-44-11A(H) DM72-RM-16-PN-4-44-11A(H)
 DM72-RM-20-PN-4-44-11A(H)

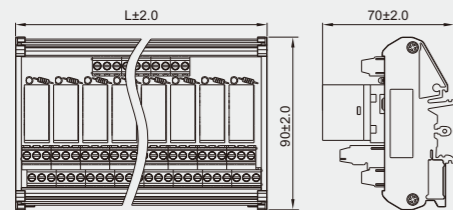
Dimensions

P/N	L * W * H mm
DM72-RM-04-PN-4-44-11A(H)	72 * 90 * 70
DM72-RM-08-PN-4-44-11A(H)	133 * 90 * 70
DM72-RM-12-PN-4-44-11A(H)	198 * 90 * 70
DM72-RM-16-PN-4-44-11A(H)	258 * 90 * 70
DM72-RM-20-PN-4-44-11A(H)	319 * 90 * 70

Performance Parameters

Withstand Voltage	500VAC 50Hz (1min)
Insulation Resistance	1000MQ/500VDC
Coil Voltage	24VDC
Load Voltage	30VDC/240VAC
Load Current	5A
Load Type	2NO + 2NC
Ambient Temperature	-20~+70°C
Maximum Torque	0.4Nm(3.54Lb-In)
Wire Range	26-12AWG
Mounting	TS-15 TS-32 TS-35

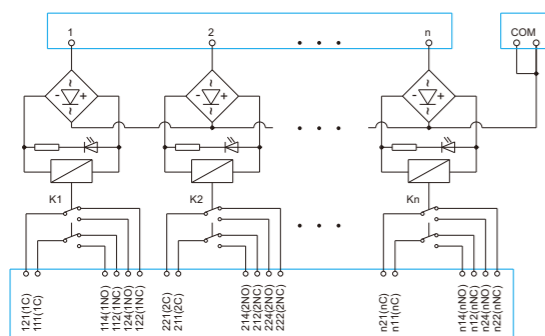
Circuit Diagram

DM72-RM-04-PN-4-44-11A(H) DM72-RM-08-PN-4-44-11A(H)
 DM72-RM-12-PN-4-44-11A(H) DM72-RM-16-PN-4-44-11A(H)
 DM72-RM-20-PN-4-44-11A(H)

Relay P/N

Omron relay P/N: G2R-2 24VDC, the relay is consumable, if the service life of the same specification relay replacement.

- ⊙ Please confirm the output contact capacity before use, do not exceed its scope.

Wiring Method

- Input control signal through 1 to 1 wiring of terminal block.
- When the control signal is NPN (low signal input), connect COM to 24V.
- When the control signal is PNP (high signal input), connect COM to 0V.

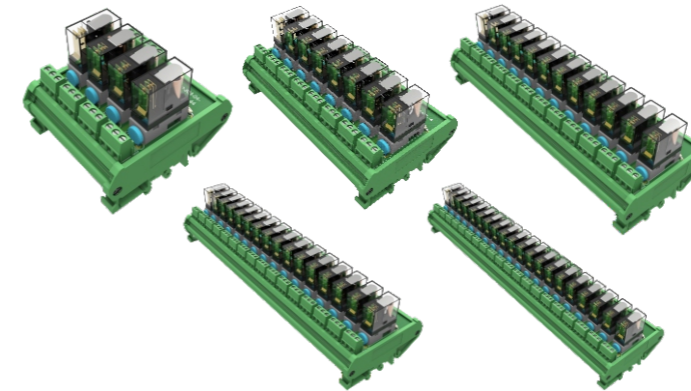
Features

- Including 4, 8, 12, 16, 20 bit independent relay circuits.
- Applicable to NPN, PNP controller.
- The relay adopts 1C/O node and 1 to 1 output of the output end.
- Save wiring space, time and cost.
- Convenient for repair and maintenance.

DM72-RM-04-PN-2-44-101A(H) DM72-RM-08-PN-2-44-101A(H)
 DM72-RM-12-PN-2-44-101A(H) DM72-RM-16-PN-2-44-101A(H)
 DM72-RM-20-PN-2-44-101A(H)

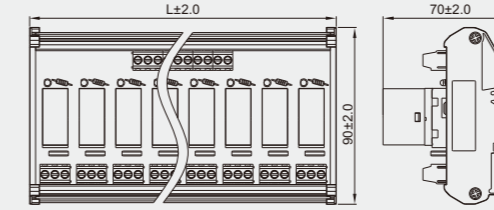
Dimensions

P/N	L * W * H mm
DM72-RM-04-PN-2-44-101A(H)	81.5 * 90 * 70
DM72-RM-08-PN-2-44-101A(H)	156 * 90 * 70
DM72-RM-12-PN-2-44-101A(H)	230 * 90 * 70
DM72-RM-16-PN-2-44-101A(H)	305 * 90 * 70
DM72-RM-20-PN-2-44-101A(H)	380 * 90 * 70

Performance Parameters

Withstand Voltage	500VAC 50Hz (1min)
Insulation Resistance	1000MQ/500VDC
Coil Voltage	24VDC
Load Voltage	30VDC/240VAC
Load Current	16A
Load Type	1NO + 1NC
Ambient Temperature	-20~+70°C
Maximum Torque	0.4Nm(3.54Lb-In)
Wire Range	26-12AWG
Mounting	TS-15 TS-32 TS-35

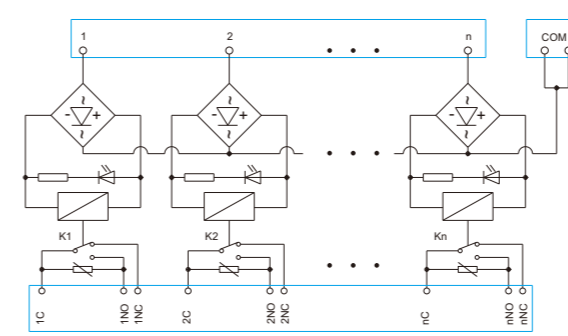
Circuit Diagram

DM72-RM-04-PN-2-44-101A(H) DM72-RM-08-PN-2-44-101A(H)
 DM72-RM-12-PN-2-44-101A(H) DM72-RM-16-PN-2-44-101A(H)
 DM72-RM-20-PN-2-44-101A(H)

Relay P/N

Omron relay P/N: G2R-1-E 24VDC, the relay is consumable, if the service life of the same specification relay replacement.

- ⊙ Please confirm the output contact capacity before use, do not exceed its scope.

Wiring Method

- Input control signal through 1 to 1 wiring of terminal block.
- When the control signal is NPN (low signal input), connect COM to 24V.
- When the control signal is PNP (high signal input), connect COM to 0V.

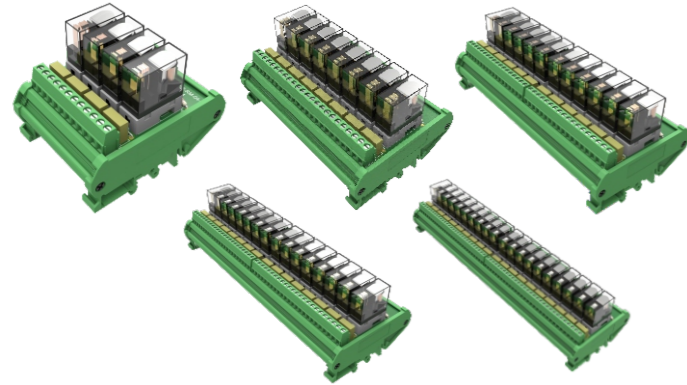
Features

- Including 4, 8, 12, 16, 20 bit independent relay circuits.
- Applicable to NPN, PNP controller.
- The relay adopts 1C/O node and 1 to 1 output of the output end.
- Save wiring space, time and cost.
- Convenient for repair and maintenance.

DM72-RM-04-PN-2-44-11A(H) DM72-RM-08-PN-2-44-11A(H)
 DM72-RM-12-PN-2-44-11A(H) DM72-RM-16-PN-2-44-11A(H)
 DM72-RM-20-PN-2-44-11A(H)

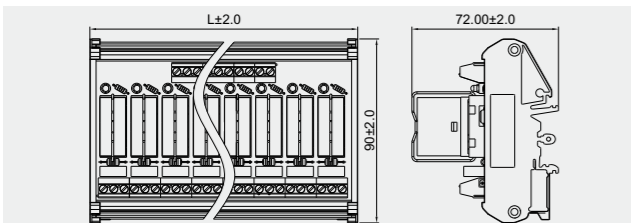
Dimensions

P/N	L * W * H mm
DM72-RM-04-PN-2-44-11A(H)	70 * 90 * 70
DM72-RM-08-PN-2-44-11A(H)	131 * 90 * 70
DM72-RM-12-PN-2-44-11A(H)	194 * 90 * 70
DM72-RM-16-PN-2-44-11A(H)	255 * 90 * 70
DM72-RM-20-PN-2-44-11A(H)	316 * 90 * 70

Performance Parameters

Withstand Voltage	500VAC 50Hz (1min)
Insulation Resistance	1000MQ/500VDC
Coil Voltage	24VDC
Load Voltage	30VDC/240VAC
Load Current	10A
Load Type	1NO + 1NC
Ambient Temperature	-20~+70°C
Maximum Torque	0.4Nm(3.54Lb-In)
Wire Range	26-12AWG
Mounting	TS-15 TS-32 TS-35

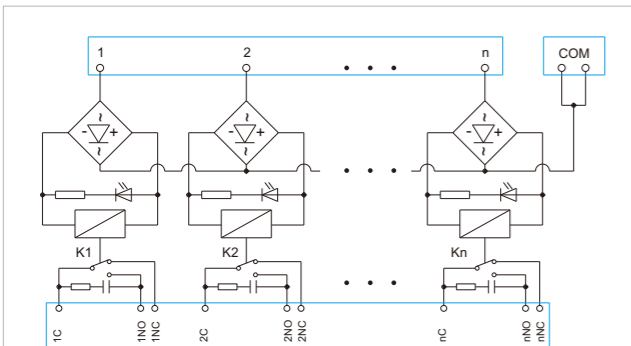
Circuit Diagram

DM72-RM-04-PN-2-44-11A(H) DM72-RM-08-PN-2-44-11A(H)
 DM72-RM-12-PN-2-44-11A(H) DM72-RM-16-PN-2-44-11A(H)
 DM72-RM-20-PN-2-44-11A(H)

Relay P/N

Omron relay P/N: G2R-1 24VDC, the relay is consumable, if the service life of the same specification relay replacement.

☉ Please confirm the output contact capacity before use, do not exceed its scope.

Wiring Method

- Input control signal through 1 to 1 wiring of terminal block.
- When the control signal is NPN (low signal input), connect COM to 24V.
- When the control signal is PNP (high signal input), connect COM to 0V.

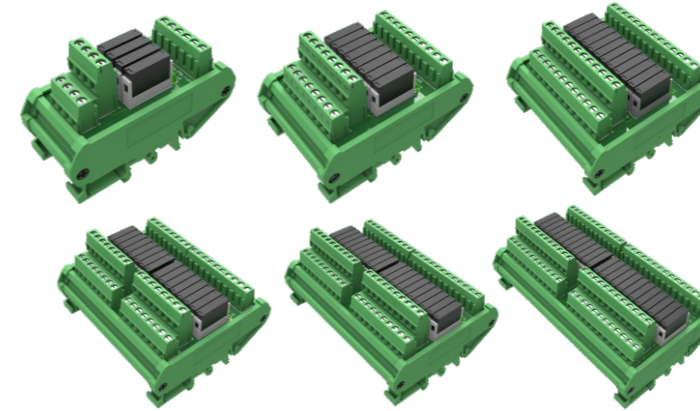
Features

- Including 4, 8, 12, 16, 20, 24 bit independent relay circuits.
- Applicable to NPN, PNP controller.
- The relay adopts 1N/O node and 1 to 1 output of the output end.
- Save wiring space, time and cost.
- Convenient for repair and maintenance.

DM72-RMUS-04-PN-1-44-00A(H) DM72-RMUS-08-PN-1-44-00A(H)
 DM72-RMUS-12-PN-1-44-00A(H) DM72-RMUS-16-PN-1-44-00A(H)
 DM72-RMUS-20-PN-1-44-00A(H) DM72-RMUS-24-PN-1-44-00A(H)

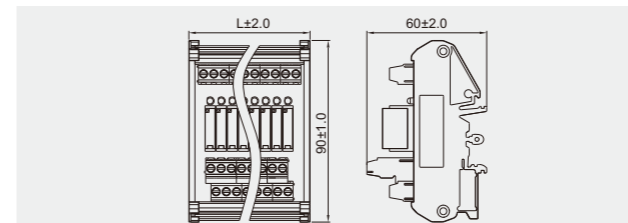
Dimensions

P/N	L * W * H mm
DM72-RMUS-04-PN-1-44-00A(H)	40 * 90 * 60
DM72-RMUS-08-PN-1-44-00A(H)	60 * 90 * 60
DM72-RMUS-12-PN-1-44-00A(H)	80 * 90 * 60
DM72-RMUS-16-PN-1-44-00A(H)	103 * 90 * 60
DM72-RMUS-20-PN-1-44-00A(H)	123 * 90 * 60
DM72-RMUS-24-PN-1-44-00A(H)	145 * 90 * 60

Performance Parameters

Withstand Voltage	500VAC 50Hz (1min)
Insulation Resistance	1000MQ/500VDC
Coil Voltage	24VDC
Load Voltage	30VDC/240VAC
Load Current	5A
Load Type	1NO
Ambient Temperature	-20~+70°C
Maximum Torque	0.4Nm(3.54Lb-In)
Wire Range	26-12AWG
Mounting	TS-15 TS-32 TS-35

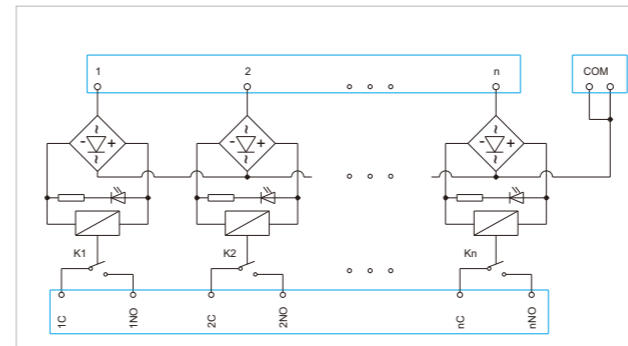
Circuit Diagram

DM72-RMUS-04-PN-1-44-00A(H) DM72-RMUS-08-PN-1-44-00A(H)
 DM72-RMUS-12-PN-1-44-00A(H) DM72-RMUS-16-PN-1-44-00A(H)
 DM72-RMUS-20-PN-1-44-00A(H) DM72-RMUS-24-PN-1-44-00A(H)

Relay P/N

Panasonic relay P/N: APAN3124, the relay is consumable, if the service life of the same specification relay replacement.

☉ Please confirm the output contact capacity before use, do not exceed its scope.

Wiring Method

- Input control signal through 1 to 1 wiring of terminal block.
- When the control signal is NPN (low signal input), connect COM to 24V.
- When the control signal is PNP (high signal input), connect COM to 0V.

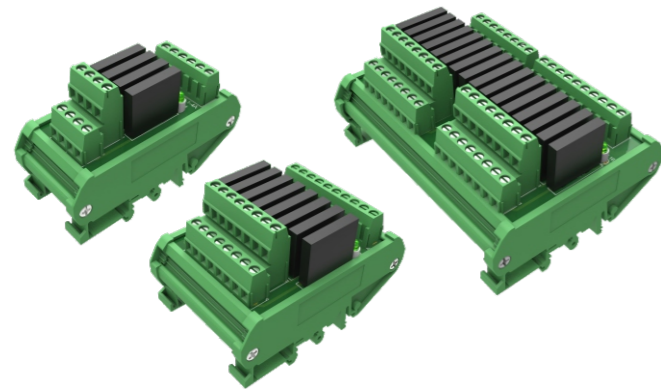

DM72-RME-04-PN-1-4A-00A(H)
DM72-RME-08-PN-1-4A-00A(H)
DM72-RME-16-PN-1-4A-00A(H)

Features

- Including 4, 8, 16 bit independent Solid State relay circuits.
- Applicable to NPN, PNP controller.
- The relay adopts 1N/O node and 1 to 1 output of the output end.
- MOS tube output, no mechanical contact.
- Save wiring space, time and cost.
- Convenient for repair and maintenance.

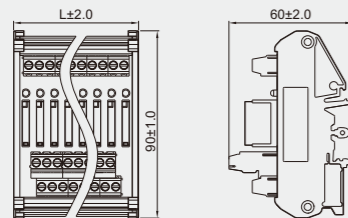
Dimensions

P/N	L * W * H mm
DM72-RME-04-PN-1-4A-00A(H)	40 * 90 * 60
DM72-RME-08-PN-1-4A-00A(H)	62 * 90 * 60
DM72-RME-16-PN-1-4A-00A(H)	117 * 90 * 60

Performance Parameters

Input Voltage	20VDC~28VDC
Maximum Load Current	2A
Surge Conducts Current	30A(60Hz 1 cycle)
Open state leakage current	1.5mA or less
Load voltage (peak AC)	75~264VAC
Actuation Time	1ms以下
Reset Time	1/2 cycle + 1ms or less
Insulation Resistance	1000MQ/500VDC
Ambient Temperature	-20~+70°C
Maximum Torque	0.4Nm(3.54Lb-In)
Wire Range	26-12AWG
Mounting	TS-15 TS-32 TS-35

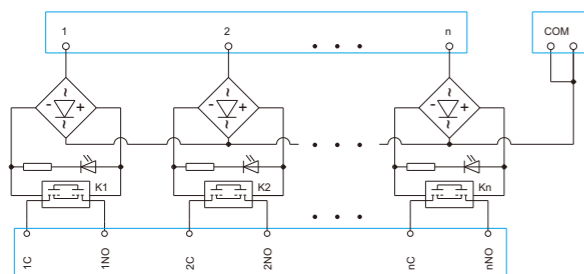
Circuit Diagram

DM72-RME-04-PN-1-4A-00A(H) DM72-RME-08-PN-1-4A-00A(H)
DM72-RME-16-PN-1-4A-00A(H)

Relay P/N

Panasonic relay P/N: AQQ22224

© Please confirm the output contact capacity before use, do not exceed its scope.

Wiring Method

- Input control signal through 1~n.
- When the control signal is NPN (low signal input), connect COM to 24V.
- When the control signal is PNP (high signal input), connect COM to 0V.

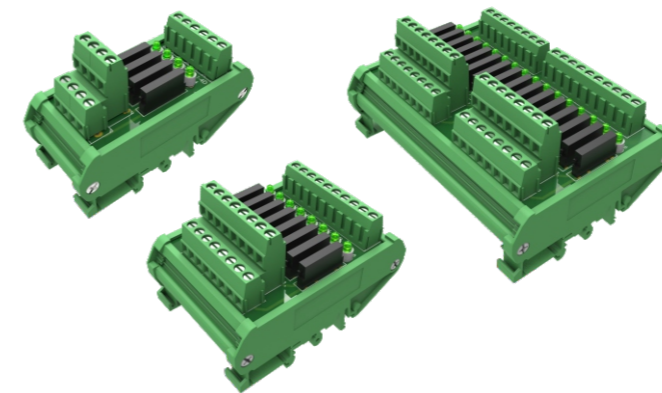

DM72-RME-04-PN-1-4D-00A(H)
DM72-RME-08-PN-1-4D-00A(H)
DM72-RME-16-PN-1-4D-00A(H)

Features

- Including 4, 8, 16 bit independent Solid State relay circuits.
- Applicable to NPN, PNP controller.
- The relay adopts 1N/O node and 1 to 1 output of the output end.
- MOS tube output, no mechanical contact, AC/DC Universal Output.
- Save wiring space, time and cost.
- Convenient for repair and maintenance.

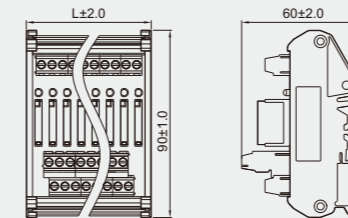
Dimensions

P/N	L * W * H mm
DM72-RME-04-PN-1-4D-00A(H)	40 * 90 * 60
DM72-RME-08-PN-1-4D-00A(H)	62 * 90 * 60
DM72-RME-16-PN-1-4D-00A(H)	117 * 90 * 60

Performance Parameters

Input Voltage	20VDC~28VDC
Input Allowable Loss	75mW
Maximum Load Current	3A
Peak Load Current	9A(100ms)
Open state leakage current	10uA
Load voltage (peak AC)	60VAC/60VDC
Output Loss	1.6W
Actuation Time	Average 2.46ms Max. 5.64ms
Reset Time	Average 0.22ms Max. 3.0ms
Highest Frequency	0.5 times/S
Insulation Resistance	1000MQ/500VDC
Ambient Temperature	-20~+70°C
Maximum Torque	0.4Nm(3.54Lb-In)
Wire Range	26-12AWG
Mounting	TS-15 TS-32 TS-35

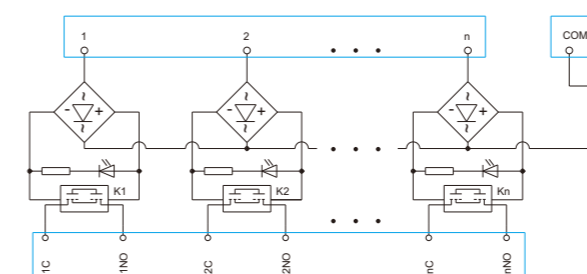
Circuit Diagram

DM72-RME-04-PN-1-4D-00A(H) DM72-RME-08-PN-1-4D-00A(H)
DM72-RME-16-PN-1-4D-00A(H)

Relay P/N

Panasonic relay P/N: AQQ2202

© Please confirm the output contact capacity before use, do not exceed its scope.

Wiring Method

- Input control signal through 1~n.
- When the control signal is NPN (low signal input), connect COM to 24V.
- When the control signal is PNP (high signal input), connect COM to 0V.

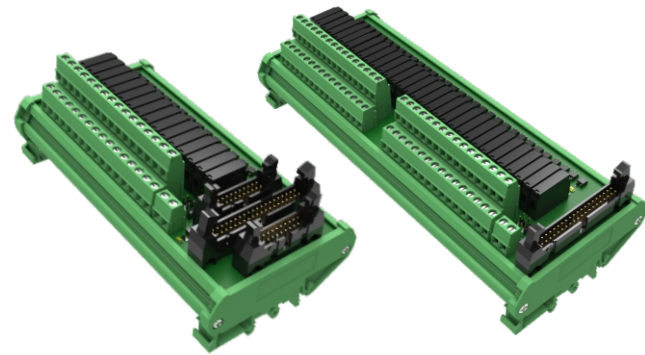

DM72-RMUS-16-PN-1-4M-00A(H)
DM72-RMUS-32-PN-1-4M-00A(H)

Features

- Including 16, 32 bit independent relay circuits.
- Switch NPN, PNP through jumper.
- The relay adopts 1NO node, and the output terminal outputs one to one.
- Save wiring space, time and cost.
- Convenient for repair and maintenance.

Dimensions

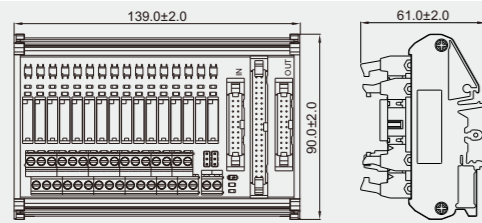

DM72-RMUS-16-PN-1-4M-00A(H)

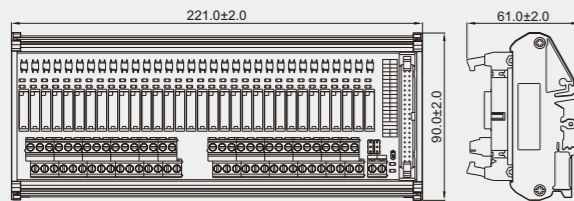

DM72-RMUS-32-PN-1-4M-00A(H)

Performance Parameters

Withstand Voltage	500VAC 50Hz (1min)
Insulation Resistance	1000MQ/500VDC
Coil Voltage	24VDC
Load Voltage	30VDC/240VAC
Load Current	5A
Load Type	1NO
Ambient Temperature	-20~+70°C
Maximum Torque	0.4Nm(3.54Lb-In)
Wire Range	26-12AWG
Mounting	TS-15 TS-32 TS-35
Relay Brand and Type	Panasonic APAN3124

Suitable PLC

MITSUBISHI Qseries	FX1NC-16MT/32MT	QY41P/QY42P
	FX2NC-16MT/32MT/64MT/96MT	QY71P/QH42P
	FX3UC-16MT/32MT/64MT/96MT	LY41NT1P / LY42NT1P

Related Products

DX210-2 DX210-4

Wiring Method

- Make sure to power off first, connect 0V to the terminal "0V" and 24V to the terminal "VCC".
- 40P row insert 40 core connector or Insert 20P row wires 20P "IN".
- Choose one from two kinds of control signal connection methods, do not repeat wiring.
- When the control signal is NPN, short-circuit COM and VCC.
- When the control signal is PNP, short-circuit COM and 0V.
- YCOM is used to control the voltage of A3, B3, A4 and B4. Users can make short connection according to their own requirements.

- Make sure to power off first, connect 0V to the terminal "0V" and 24V to the terminal "VCC".
- When the control signal is NPN, short-circuit COM and VCC.
- When the control signal is PNP, short-circuit COM and 0V.
- YCOM is used to control the voltage of A3, B3, A4 and B4. Users can make short connection according to their own requirements.

Circuit Diagram

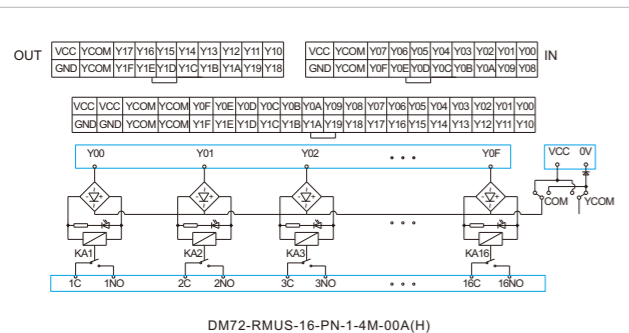

DM72-RMUS-16-PN-1-4M-00A(H)

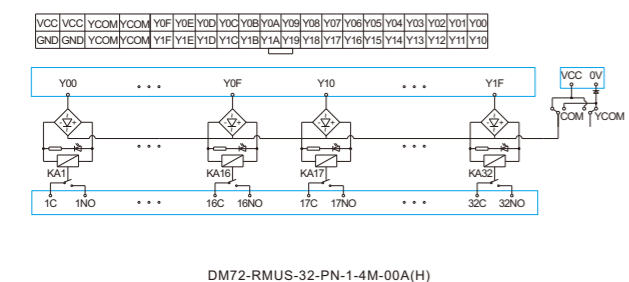

DM72-RMUS-32-PN-1-4M-00A(H)

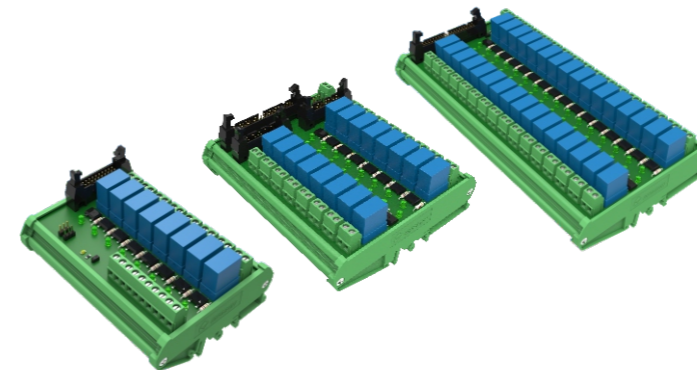

DM72-RMS-08-PN-1-4M-00A(H)
DM108-RMS-16-PN-1-4M-00A(H)
DM108-RMS-32-PN-1-4M-00A(H)

Features

- Including 8, 16, 32 bit independent relay circuits.
- Switch NPN, PNP through jumper.
- The relay adopts 1N/O node, and the output terminal outputs one to one.
- Save wiring space, time and cost.
- Convenient for repair and maintenance.

Dimensions

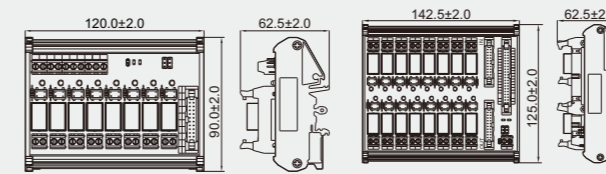

DM72-RMS-08-PN-1-4M-00A(H)

DM108-RMS-16-PN-1-4M-00A(H)

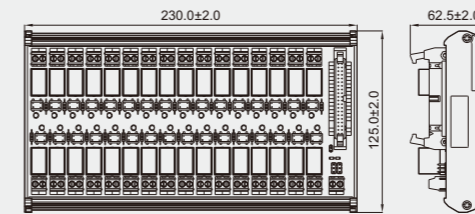

DM108-RMS-32-PN-1-4M-00A(H)

Performance Parameters

Withstand Voltage	500VAC 50Hz (1min)
Insulation Resistance	1000MQ/500VDC
Coil Voltage	24VDC
Load Voltage	30VDC/240VAC
Load Current	10A
Load Type	1NO
Ambient Temperature	-20~+70°C
Maximum Torque	0.4Nm(3.54Lb-In)
Wire Range	26-12AWG
Mounting	TS-15 TS-32 TS-35
Relay Brand and Type	TE OJE-SS-124HM

Suitable PLC

MITSUBISHI Qseries	FX1NC-16MT/32MT	QY41P/QY42P
	FX2NC-16MT/32MT/64MT/96MT	QY71P/QH42P
	FX3UC-16MT/32MT/64MT/96MT	LY41NT1P / LY42NT1P

Related Products

DX210-2 DX210-4

Wiring Method

- Make sure to power off first, connect 0V to the terminal "0V" and 24V to the terminal "VCC".
- 20P row wires inserted into 20 core connectors.
- Control signal of two kinds of connection, do not repeat wiring.
- When the control signal is NPN, short-circuit COM and VCC.
- When the control signal is PNP, short-circuit COM and 0V.
- YCOM is used to control the voltage of A3, B2. Users can make short connection according to their own requirements.

- Make sure to power off first, connect 0V to the terminal "0V" and 24V to the terminal "VCC".
- 40P row insert 40 core connector or Insert 20P row wires 20P "IN".
- Control signal of two kinds of connection, do not repeat wiring.
- When the control signal is NPN, short-circuit COM and VCC.
- When the control signal is PNP, short-circuit COM and 0V.
- YCOM is used to control the voltage of A3, B3, A4 and B4. Users can make short connection according to their own requirements.

- Make sure to power off first, connect 0V to the terminal "0V" and 24V to the terminal "VCC".
- When the control signal is NPN, short-circuit COM and VCC.
- When the control signal is PNP, short-circuit COM and 0V.
- YCOM is used to control the voltage of A3, B3, A4 and B4. Users can make short connection according to their own requirements.

Circuit Diagram

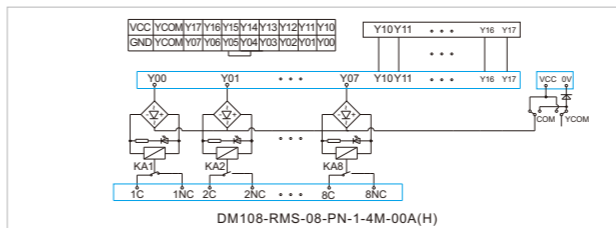

DM108-RMS-08-PN-1-4M-00A(H)

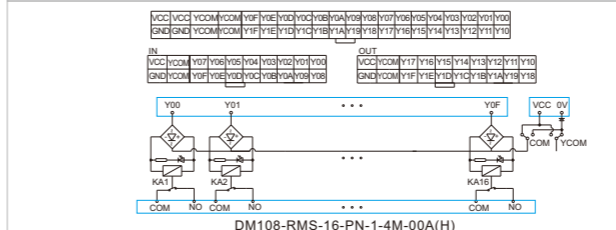

DM108-RMS-16-PN-1-4M-00A(H)

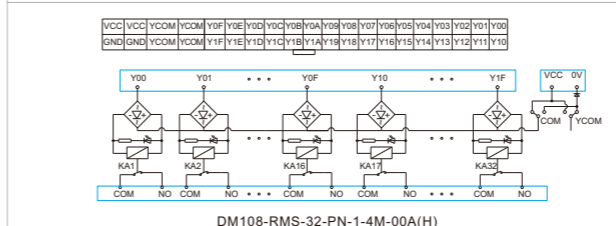

DM108-RMS-32-PN-1-4M-00A(H)

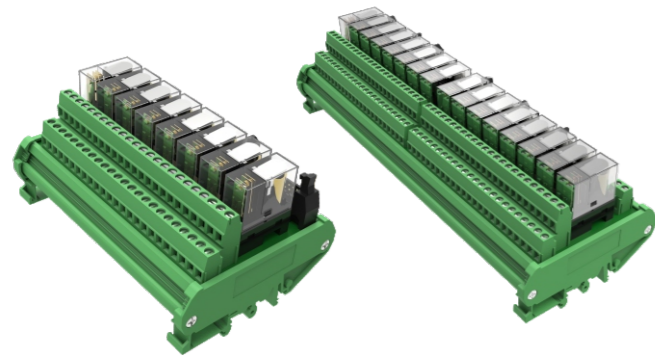

DM72-RM-08-PN-4-4M-01A(H)
DM72-RM-16-PN-4-4M-01A(H)

Features

- This module provides 8, 16 bit independent relay circuits.
- Switch NPN,PNP through jumper.
- The relay adopts 2NO/2NC node, and the output terminal outputs one to one.
- Save wiring space, time and cost.
- Convenient for repair and maintenance.

Dimensions

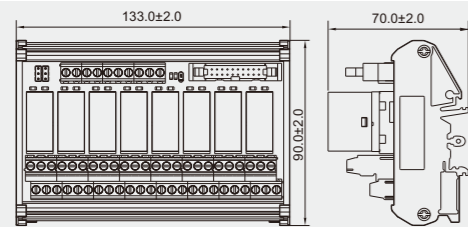

DM72-RM-08-PN-4-4M-01A(H)

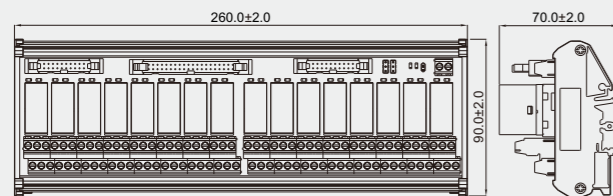

DM72-RM-16-PN-4-4M-01A(H)

Circuit Diagram

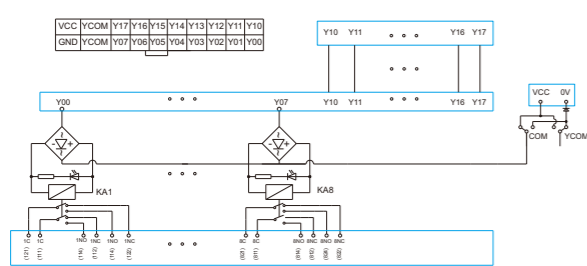

DM72-RM-08-PN-4-4M-01A(H)

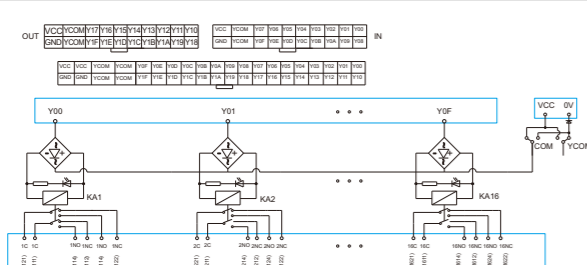

DM72-RM-16-PN-4-4M-01A(H)

Performance Parameters

Withstand Voltage	500VAC 50Hz (1min)
Insulation Resistance	1000MQ/500VDC
Coil Voltage	24VDC
Load Voltage	30VDC/240VAC
Load Current	5A
Load Type	2NO/2NC
Ambient Temperature	-20~+70°C
Maximum Torque	0.4Nm(3.54Lb-In)
Wire Range	26-12AWG
Mounting	TS-15 TS-32 TS-35
Relay Brand and Type	OMRON G2R-2

Suitable PLC

MITSUBISHI Qseries	FX1NC-16MT/32MT	QY41P/QY42P
	FX2NC-16MT/32MT/64MT/96MT	QY71P/QH42P
	FX3UC-16MT/32MT/64MT/96MT	LY41NT1P/LY42NT1P

Related Products

DX210-2 DX210-4

Wiring Method

- Make sure to power off first, connect 0V to the terminal "0V" and 24V to the terminal "VCC".
- 20P row wires inserted into 20 core connectors.
- Control signal of two kinds of connection, do not repeat wiring.
- When the control signal is NPN, short-circuit COM and VCC.
- When the control signal is PNP, short-circuit COM and 0V.
- YCOM is used to control the voltage of A3, B2. Users can make short connection according to their own requirements.

- Make sure to power off first, connect 0V to the terminal "0V" and 24V to the terminal "VCC".
- 40P row insert 40 core connector or Insert 20P row wires 20P "IN".
- Control signal of two kinds of connection, do not repeat wiring.
- When the control signal is NPN, short-circuit COM and VCC.
- When the control signal is PNP, short-circuit COM and 0V.
- YCOM is used to control the voltage of A3, B3, A4 and B4. Users can make short connection according to their own requirements.

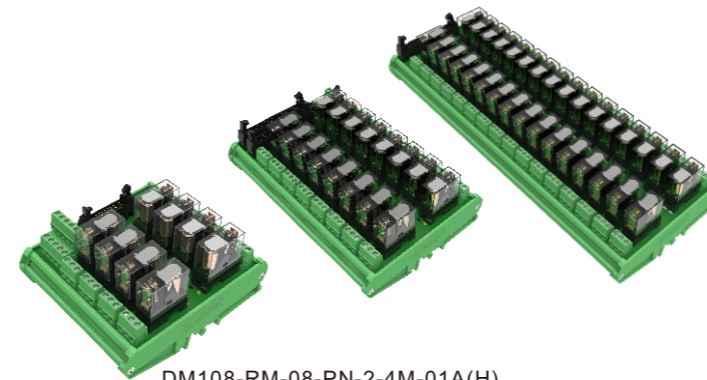

DM108-RM-08-PN-2-4M-01A(H)
DM108-RM-16-PN-2-4M-01A(H)
DM108-RM-32-PN-2-4M-01A(H)

Features

- This module provides 8, 16, 32 bit independent relay circuits.
- Switch NPN,PNP through jumper.
- The relay adopts 1NO/1NC node, and the output terminal outputs one to one.
- Save wiring space, time and cost.
- Convenient for repair and maintenance.

Dimensions

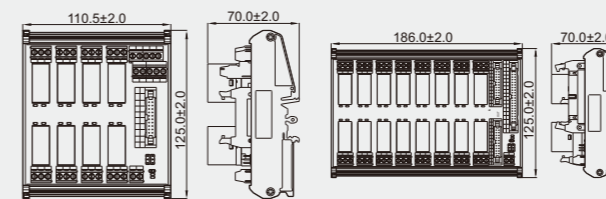

DM108-RM-08-PN-2-4M-01A(H)

DM108-RM-16-PN-2-4M-01A(H)

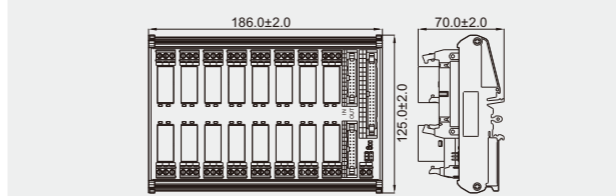

DM108-RM-32-PN-2-4M-01A(H)

Circuit Diagram

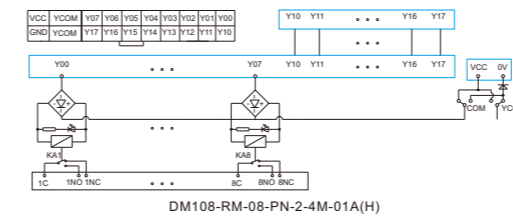

DM108-RM-08-PN-2-4M-01A(H)

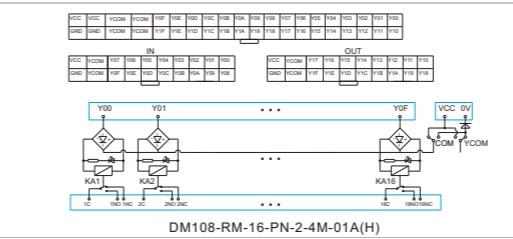

DM108-RM-16-PN-2-4M-01A(H)

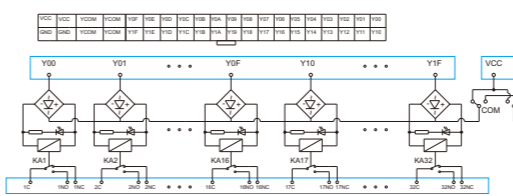

DM108-RM-32-PN-2-4M-01A(H)

Performance Parameters

Withstand Voltage	500VAC 50Hz (1min)
Insulation Resistance	1000MQ/500VDC
Coil Voltage	24VDC
Load Voltage	30VDC/240VAC
Load Current	16A
Load Type	1NO + 1NC
Ambient Temperature	-20~+70°C
Maximum Torque	0.4Nm(3.54Lb-In)
Wire Range	26-12AWG
Mounting	TS-15 TS-32 TS-35
Relay Brand and Type	OMRON G2R-1-E

Suitable PLC

MITSUBISHI Qseries	FX1NC-16MT/32MT	QY41P/QY42P
	FX2NC-16MT/32MT/64MT/96MT	QY71P/QH42P
	FX3UC-16MT/32MT/64MT/96MT	LY41NT1P/LY42NT1P

Related Products

DX210-2 DX210-4

Wiring Method

- Make sure to power off first, connect 0V to the terminal "0V" and 24V to the terminal "VCC".
- 20P row wires inserted into 20 core connectors.
- Control signal of two kinds of connection, do not repeat wiring.
- When the control signal is NPN, short-circuit COM and VCC.
- When the control signal is PNP, short-circuit COM and 0V.
- YCOM is used to control the voltage of A3, B2. Users can make short connection according to their own requirements.

- Make sure to power off first, connect 0V to the terminal "0V" and 24V to the terminal "VCC".
- 40P row insert 40 core connector or Insert 20P row wires 20P "IN".
- Control signal of two kinds of connection, do not repeat wiring.
- When the control signal is NPN, short-circuit COM and VCC.
- When the control signal is PNP, short-circuit COM and 0V.
- YCOM is used to control the voltage of A3, B3, A4 and B4. Users can make short connection according to their own requirements.

- Make sure to power off first, connect 0V to the terminal "0V" and 24V to the terminal "VCC".
- When the control signal is NPN, short-circuit COM and VCC.
- When the control signal is PNP, short-circuit COM and 0V.
- YCOM is used to control the voltage of A3, B3, A4 and B4. Users can make short connection according to their own requirements.